

Flight Physics & Aircraft Control

with an introduction to aerobatics

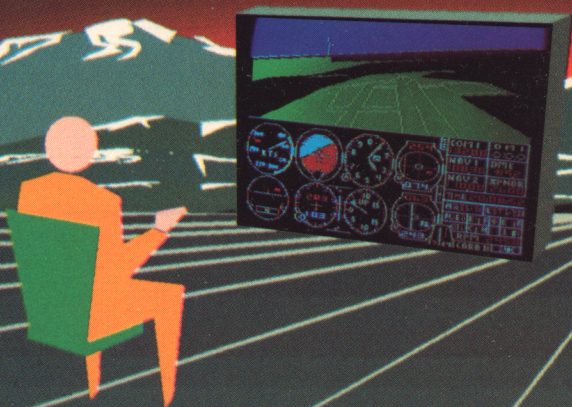

sub**LOGIC**

Flight Physics & Aircraft Control

with an introduction to aerobatics

by Stu Moment 1930582 CFI
Introduction to Aerobatics
by Tom Emanuel 1545472 CFI
Technical Editor – Tom Emanuel
Copy Editor – Norm Olsen

©SubLOGIC Corporation 1984

First Edition
Second Printing
All Rights Reserved
SubLOGIC Corporation
713 Edgebrook Drive
Champaign Illinois 61820

Table of Contents

Introduction	9
Section One – Flight Physics & Aircraft Control	11
Standard Terminology and Abbreviations	11
Axis of Rotation	11
Vector	11
Abbreviations	11
The Four Forces	12
Lift	13
The Bernoulli Controversy	16
Controlling Lift	17
The Stall	18
Drag	21
Parasitic Drag	21
Induced Drag	22
Total Drag	23
Weight	25
Thrust	25
Stability	26
Balance and Pitch Stability	27
Roll Stability	29
The Flight Controls	29
Physics of Aircraft Control	31
Pitch Control	31
Climb	31
Descent	32
Roll Control	33
Yaw Control	34
Drag (and Lift) Control	34
Thrust Control	34
Terminology of Flight Goals	35
Heading	35
Airspeed	35

Turn Rate	36
Pitch and Bank Attitude	37
A Summary of Flight Goals	37
The Basic Flight Maneuvers	38
Information Scan	38
Bank Control	40
Straight Flight	40
Standard Rate Turn	41
30-Degree Bank Turns	41
Pitch Control	41
Level Flight	42
Climbs	42
Cruise Descents	43
Slow Descents	44
Airspeed Transitions	44
Takeoffs	45
Section Two – Beginning Flight Lessons	47
Flight Lesson 1	48
Elevator Control	49
Taxiing	49
Pre-Takeoff Preparations	50
Takeoff and Level-off	52
Power Changes and Pitch Stability	52
Climbs and Descents	53
Instrument Takeoff, Climbs and Descents	53
Flight Lesson 2	54
Airspeed Transitions	54
Turns	55
Instrument Turns	56
Flight Lesson 3	56
Climbing and Descending Turns	56
Airspeed Transitions in Turns	57
Vertical Speed Control in Descents	57

Flight Lesson 4	58
VOR Departure	59
Flap Operations	61
Slow Flight	62
VOR Arrival	62
Airport Pattern Entry	63
Flight Lesson 5	63
VOR Departure (instrument)	64
Steep Turns	64
Accelerated Maneuver Stalls	64
VOR Arrival (instrument)	65
Flight Lesson 6	65
VOR Tracking with Wind	66
VOR Practice	70
VOR Approach	70
Flight Lesson 7	73
Cross-Country Flight	73
Flight Lesson 8	76
ILS Approach	76
Recommended Alterations to Flight Lessons	79
Section Three – Introduction to Aerobatics	81
The Spin	81
The Loop	83
Aileron Rolls	85
Inverted Flight and the Split-S	86
The Immelman	87
The Hammerhead Turn	88
The English Bunt	90
Conclusion	92
Suggested Bibliography	92

List of Tables

Table 1 – Loaded Cherokee Archer Example	25
Table 2 – Cherokee Archer Power Table	26
Table 3 – Airspeed Correction Factors	36

List of Figures

Figure 1 – Classic Four Forces of Flight	12
Figure 2 – Airfoil Terminology	13
Figure 3 – Angle of Attack	14
Figure 4 – Bernoulli's Favorite Tube	15
Figure 5 – Bernoulli Explanation of Lift	16
Figure 6 – Newton Explanation of Lift	17
Figure 7 – Airflow Separation	19
Figure 8 – Lift vs. Angle of Attack	20
Figure 9 – Parasitic Drag vs. Airspeed	22
Figure 10 – Induced Drag	23
Figure 11 – Induced Drag vs. Airspeed	24
Figure 12 – Total Drag vs. Airspeed	24
Figure 13 – Stable Loading Condition	28
Figure 14 – Positive Dynamic Pitch Stability	29
Figure 15 – Deflection of Air by the Rudder	30
Figure 16 – Steady Climb	31
Figure 17 – Steady Descent	32
Figure 18 – The Turn	33
Figure 19 – Division of Instruments	37
Figure 20 – Scan Sequence for Aircraft Control	39
Figure 21 – Taxi Chart of Willard Airport	51
Figure 22 – VOR Navigation Departure	60
Figure 23 – Flight Lesson 6 Departure	67
Figure 24 – Visualization of Drift Angle	68
Figure 25 – VOR Approach Chart	71
Figure 26 – Approach Chart Terminology	72
Figure 27 – Landmarks – Champaign to Paxton	75
Figure 28 – ILS Approach Chart	77
Figure 29 – The Spin	82

Figure 30 – The Loop	84
Figure 31 – The Aileron Roll	85
Figure 32 – Inverted Flight	86
Figure 33 – The Split-S	87
Figure 34 – The Immelman	88
Figure 35 – The Hammerhead Turn	89
Figure 36 – The English Bunt	91

Introduction

Writing a text to explain methods of flight and aircraft control is a highly abstract process. The difficulty of explaining a dynamic event such as aircraft flight control without personal “hands-on” contact seems almost insurmountable. Still, a well-designed instruction manual can provide real benefits, so the compilation of this manual was undertaken with the realization that only a qualified flight instructor in a real aircraft can teach you how to fly a real airplane.

The goal of this manual is to help you more fully enjoy the entertainment/instructional value of Flight Simulator II without letting you develop habits that could interfere with any future real flight training. We want you to have fun while practicing correct flight procedures.

A state-of-the-art simulation such as Flight Simulator II provides such a sense of realism that one must carefully analyze where this realism transfers to actual flight. The flight lessons covered in this manual are not organized the way real flight lessons would be. Some basic concepts (coordination, for example) are not covered at all while other, more advanced concepts (i.e., instrument approaches) are explained in some detail. Concepts that are covered are consistent with the simulator’s realism.

This manual is organized into three sections:

- Flight Physics and Aircraft Control**
- Beginning Flight Lessons**
- Introduction to Aerobatics**

Flight Physics and Aircraft Control should take one or two short evenings to read. It’s a crash course in basic aircraft physics designed to give you a background appropriate to the flight lessons.

The **Flight Lessons** section describes how to fly (and requests you to perform) maneuvers to absolute limits.

The section on **Aerobatics** explains how to perform many aerobatic maneuvers. Should your aircraft control be up to limits, you’ll find aerobatic flight to be quite an exhilarating experience.

If flying Flight Simulator II whets your appetite for the real thing, we recommend that you check the Yellow Pages under either "Aircraft Charter, Rental & Leasing" or "Aircraft Schools" and ask the flight school to schedule you for an hour of dual plus one-half hour of ground instruction. We encourage you to take your first flight lessons (or an occasional fun flight lesson) with an open mind. Don't let your partial knowledge of simulated aircraft flight control interfere with the knowledge that only a real flight course can provide. Use your simulator experience to enhance your aviation education.

Section One – Flight Physics & Aircraft Control

This section opens with the classic presentation of the “four forces” and the concept of stability. Since the usual objective in flying is to control the aircraft, we’ll discuss flight controls as they relate to these forces. Finally, with our newly-developed knowledge of flight physics, we will discuss flight control and the goals of flight maneuvers.

Standard Terminology & Abbreviations

Axis of Rotation

The discussions of flight physics and aircraft control frequently refer to your aircraft’s *axis of rotation*. Please check the **Pilot’s Operating Handbook**, Figure 2, if you need to review the subject. All axes of rotation pass through the aircraft’s center of mass; rotations about any axis will occur about the center of mass.

Vector

A *vector* is a representation of a force that displays both the direction and the quantity of that force.

Abbreviations

Abbreviations used in **Section One** of this manual include:

- aa – angle of attack
- CG – center of gravity
- CL – center of lift
- FAA – Federal Aviation Administration (Dept. of Transportation)
- FS2 – Flight Simulator II
- gal – gallons
- kts – knots (one knot = 1.15 miles per hour)
- lbs – pounds
- POH – Flight Simulator II Pilot’s Operating Handbook
- RPM – revolutions per minute

The Four Forces

Figure 1 illustrates the four forces of flight and shows the approximate direction in which each force operates.

LIFT is a force tending to pull the aircraft up. Most lift is generated by the wing.

DRAG is the resistance of air to an object passing through it. The direction of this force is exactly opposite to the direction of object movement.

WEIGHT – The direction of this force is toward the center of the earth.

THRUST is the force developed by your engine and applied through the propeller. Its direction is forward and generally perpendicular to the plane of propeller rotation.

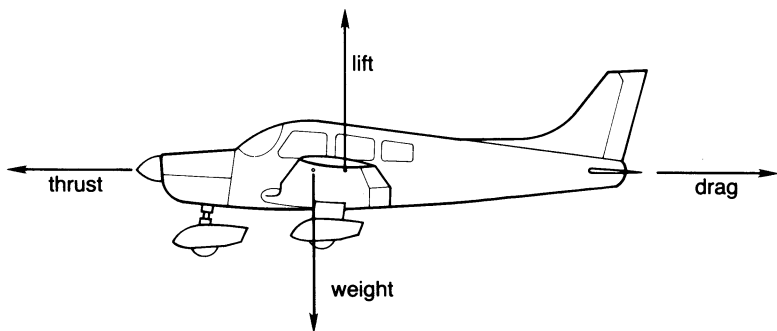

Figure 1. Classic Four Forces of Flight

Lift

Lift is created by the wing passing through air. A cross-section of the wing (airfoil) is shown in Figure 2, where some important terms are introduced.

The *mean chord line* is an imaginary line that extends from the leading edge to the trailing edge of the airfoil. It is further extended in Figure 2. *Relative wind* is the airflow caused by passing the aircraft through an airmass.

Relative wind is approximately opposite to the flight path. *Angle of attack* is the angle between the relative wind and the mean chord line. Figure 3 illustrates these terms in level, climbing, and descending flight.

Note that angle of attack does not have the same meaning as aircraft pitch attitude. The angle of attack in Figure 3 is purposely the same in all three examples (level, climbing, and descending flight) so as to emphasize this difference. In actual flight your angle of attack will often be different during different phases of the flight.

In order to understand how lift is produced, we must explore the theories of Bernoulli and Newton.

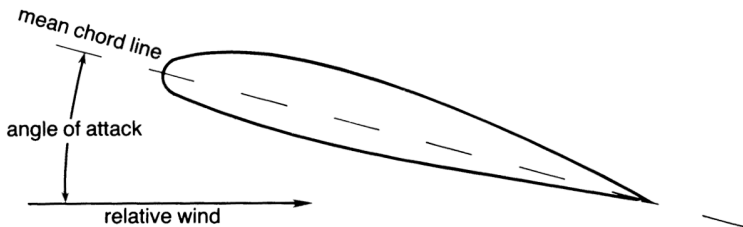
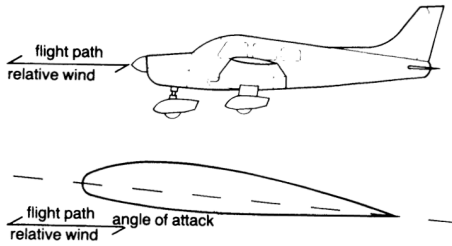
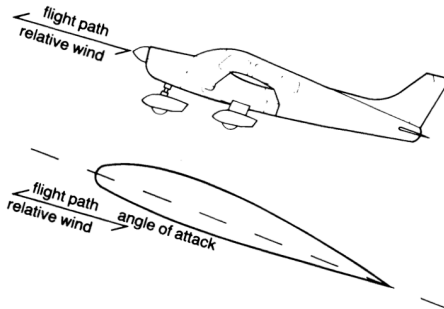

Figure 2. Airfoil Terminology



a) Level



b) Climb

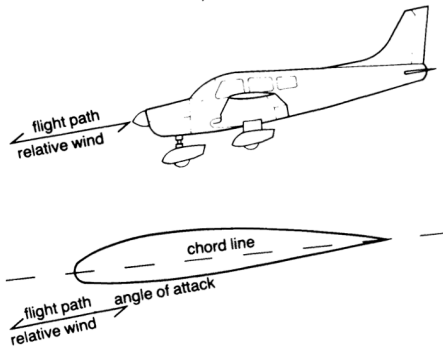

c) Descent

Figure 3. Angle of Attack: Shown in level, climbing, and descending flight. (Angle of attack is the same in all three examples illustrated.)

Bernoulli addressed the conservation of energy in fluid flow. Assuming a constant density (no compression) of the fluid, energy is held constant by decreasing pressure with increasing velocity or, conversely, by increasing pressure with decreasing velocity. This incompressibility assumption holds nearly true for airflow as well, at least at the low speeds flown by light aircraft. The classic graphic illustration of this theory usually depicts a tube of varying diameter (Figure 4).

Figure 4 shows an enclosed tube with airflow. Mass flow within the enclosed tube is the same at all points since the air can't escape. An incompressible fluid (or low-speed airflow) must increase velocity at the narrow point to maintain mass flow. If energy is to be conserved, then an increase in velocity (kinetic energy) must be balanced by a decrease in pressure (potential energy).

Figure 5 illustrates airflow past an airfoil at a positive angle of attack. The airflow over the top of the wing has a higher velocity than the airflow under the wing and, consequently, a lower pressure. A basic rule in physics states that when an imbalance exists, a force will result tending to relieve that imbalance. In the case of our airfoil this force is directed upwards, from the higher pressure to the lower pressure. This force is known as lift.

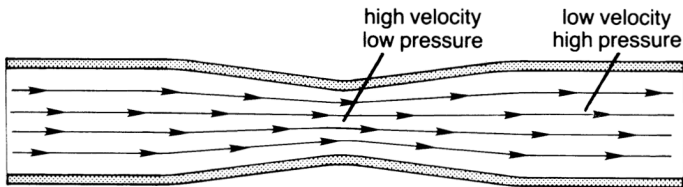

Figure 4. Bernoulli's Favorite Tube

The Bernoulli Controversy

As late as the mid 1960's many flight instructors were emphasizing Bernoulli's law as the major contributor to lift theory. This concept does go a long way in explaining lift when looking just at airflow immediately adjacent to the wing. Bernoulli's law, however, doesn't explain the forces of airflow deflected by the wing. Indeed, most modern instructors give credit to Newton for explaining the majority of lift production.

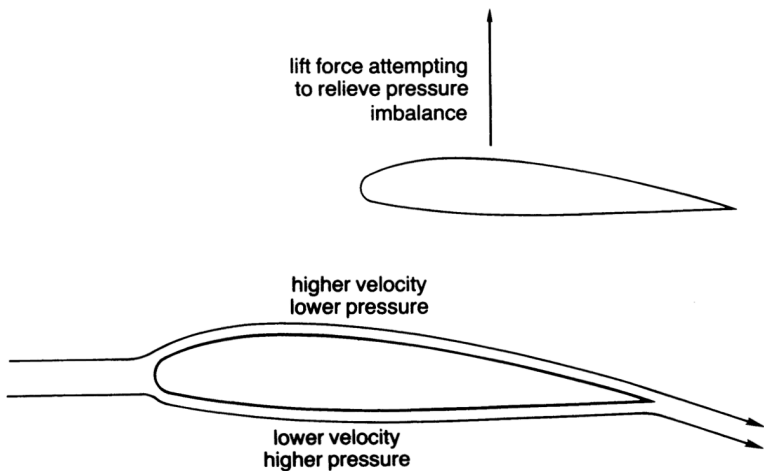

Figure 5. Bernoulli's Explanation of Lift

Newton's third law states that for every action there is an equal and opposite reaction. Figure 6 is a repeat of Figure 5 with labels changed to emphasize action-reaction theory.

Downwash is caused by the airfoil altering the direction of airflow downwards. This will occur as long as there is a positive angle of attack. Downwash is easy to understand no matter what shape the airfoil takes. In this age when fighter jets use thin, symmetrical airfoils, you can see why deflected air is considered to be the major contributor to lift.

Controlling Lift

As a pilot, you must learn how to control lift during takeoff, climbs, level flight, turns, descents, and landing. You can generally increase lift in two ways; increase airspeed or increase your angle of attack.

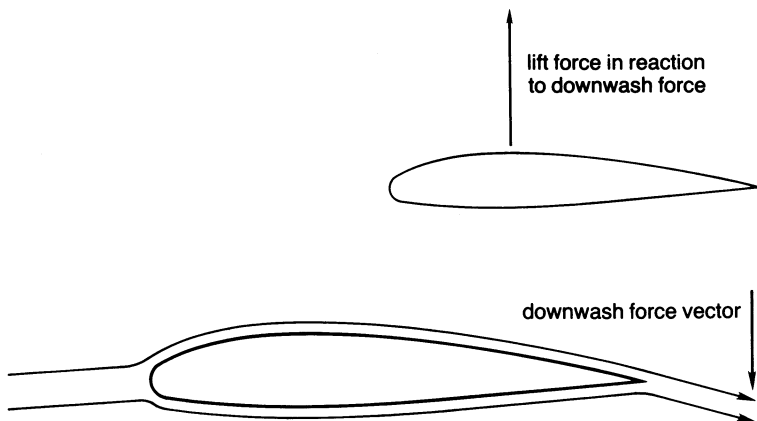

Figure 6. Newton's Explanation of Lift

Given a constant angle of attack, an increase in airspeed increases pressure differential and downwash, and therefore increases lift. Given a constant airspeed, an increased α increases pressure differential and downwash, thereby increasing lift. As a pilot, you must manage both airspeed and α in order to gain the desired flight goals. A good example would be an airspeed transition from fast cruise flight to slower flight when entering a crowded airport traffic pattern. You reduce power and the aircraft decelerates. Since the weight of your aircraft is unchanged, you must produce constant lift during the deceleration. In order to produce constant lift, you must increase the angle of attack slowly until the aircraft is stable at its new slower speed.

The Stall

There is a limit to the angle of attack that you can use to generate lift. You can alter the relative wind airflow only so far before the wind refuses to change anymore.

Figure 7 shows an airfoil at three different angles of attack. The top illustration shows an airfoil at the same α used in the previous discussion of lift generation. The middle airfoil shows an increased α . Notice that the airflow is separating from the surface near the upper trailing edge of the wing. The bottom airfoil is at stall α . The point of airflow separation is so far forward that we don't even see a downwash vector; Newton's downwash is gone. Velocity in the area aft of the separation point is very low; Bernoulli's suction is gone. And with neither law still in effect, there is no way to maintain lift.

Important Note!

What is a *stall*? A sudden loss of lift due to airflow separation from the wing.

How do you stall an airfoil? Stall is a function of angle of attack. You can stall an aircraft at any airspeed and pitch attitude if you exceed the stall angle of attack.

How do you recover from a stall? Simply reduce the angle of attack.

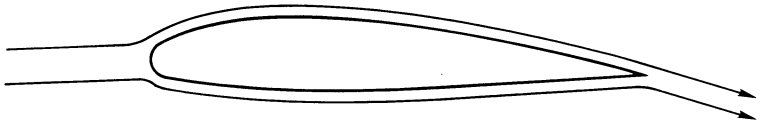

a) Low angle of attack

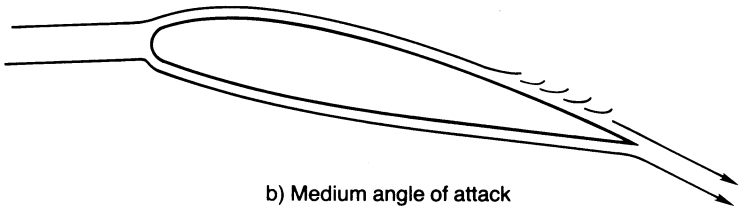

b) Medium angle of attack

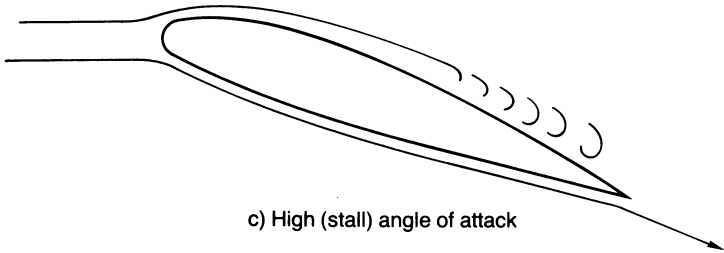

c) High (stall) angle of attack

Figure 7. Airflow Separation With Increasing Angle of Attack

Stall angle of attack depends on the airfoil shape, and is usually somewhere between 10 and 20 degrees. Generally speaking, thin airfoils will stall at a lower α while thick airfoils will stall at a higher angle of attack. Also, symmetrical airfoils will stall at lower α 's than airfoils with more bulge on the upper surface (higher camber). Figure 8 shows the lift characteristics of a typical airfoil used on training aircraft. Lift increases steadily until stall angle is reached. After this point, lift drops off suddenly.

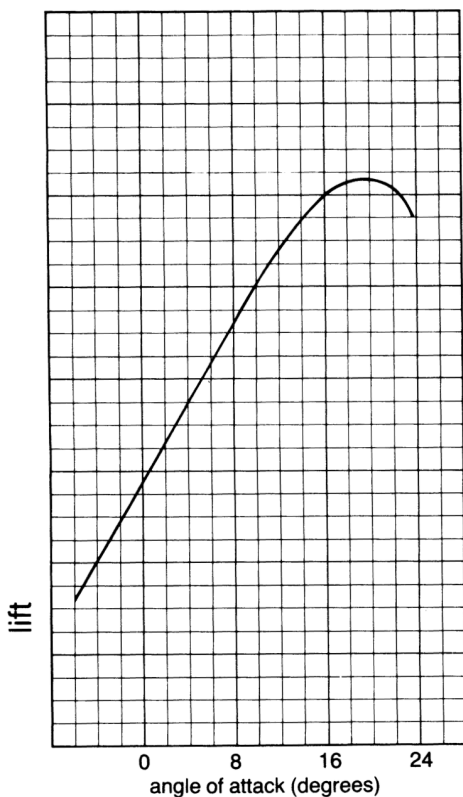

Figure 8. Lift versus Angle of Attack

As you can see, lift is a very important factor in flight. We will return to it often when discussing aircraft control, and will even touch on it during the following discussion of drag.

Drag

We have already described drag as a resistive force to the movement of the aircraft. By this definition, drag will always act along a line opposite the aircraft's flight path.

There are two types of drag that warrant separate coverage. The first is *parasitic drag*, that drag caused by the physical aircraft displacing and rubbing the airstream. The second type is *induced drag*, an unusual phenomenon peculiar to aircraft. Induced drag is a byproduct of the generation of lift.

Parasitic Drag

You are already familiar with the parasitic drag encountered, for example, when driving a car. Parasitic drag caused by air displacement is called *form drag*. If you view the front end of a car or an airplane and make a filled-in outline of this view, you will see how much form the the vehicle has. Streamlining the form can help reduce drag but, assuming good streamlining in all cases, more form means more parasitic drag.

Skin friction is roughly proportional to the amount of surface exposed to the airstream. More surface means more drag.

Parasitic drag increases non-linearly with increasing airspeed. The dynamic pressure of air is a function of the square of the velocity. Assume that you are moving in your car at a speed of 30 mph. If you accelerate to 60 mph you will experience four times the drag. Cruise at 120 mph and the drag becomes sixteen times as great as it was at 30 mph. This fact assumes a great deal of importance when you realize that thrust is needed to overcome that drag. At 30 mph your car may require 25 pounds of thrust to sustain speed. At 60 mph you'll need 100 pounds, and at 120 mph you'll need 400 pounds of thrust to sustain speed. A typical Parasitic Drag vs. Airspeed curve is shown in Figure 9.

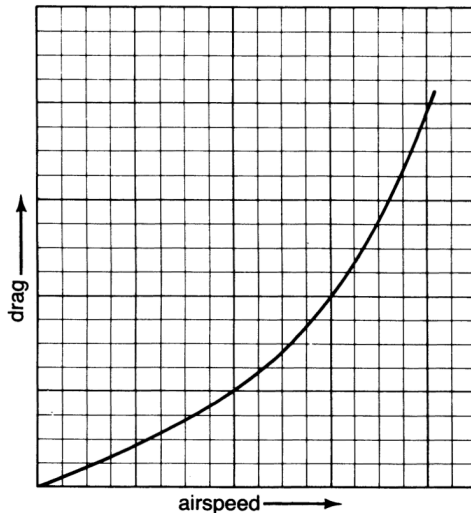

Figure 9. Parasitic Drag versus Airspeed

Induced Drag

While creating lift, your airfoil changes the direction of airflow in many ways. You're already familiar with downwash. This downward deflection of air changes the relative wind in the vicinity of the wing to a slightly downward direction. As a result, the true α is different from the apparent α derived from the relative wind opposite the flight path.

Lift is produced perpendicular to the relative wind direction. A relative wind in a slightly downward direction will give us a real lift vector with a component toward the rear. This rearward component is known as induced drag. Figure 10 illustrates the concept of induced drag.

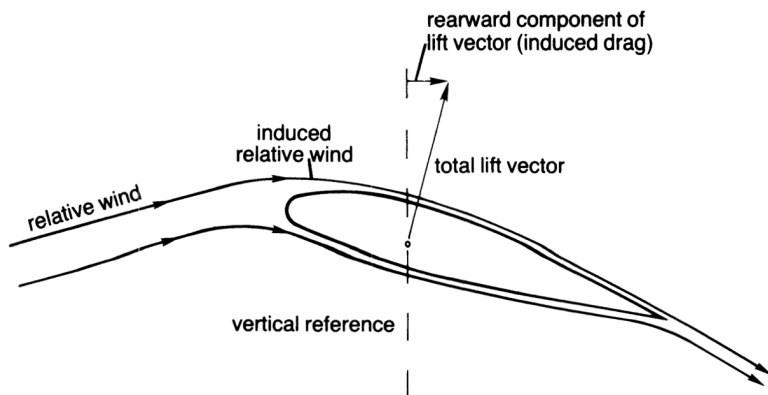

Figure 10. Induced Drag Due To Induced Relative Wind

The induced drag vector is increased when the angle of attack increases. Given that weight, bank angle, and other factors are held constant, a slower airspeed demands a higher angle of attack to produce the same lift. Therefore, the slower the airspeed, the greater the induced drag. Figure 11 shows a graph of Induced Drag vs. Airspeed. Note that it is nonlinear. As velocity decreases, induced drag increases inversely proportional to the square of the velocity. This phenomenon can be explained when you remember that dynamic pressure from the airstream increases as the square of velocity. Greater dynamic pressure means more lift production capability. Drop your airspeed by one-half and you only get one-quarter the lift production capability. Therefore, you will need quite an increase in *aa* to produce the same lift, and induced drag will also increase dramatically.

Total Drag

Total drag equals parasitic drag plus induced drag. Figure 12 shows both parasitic and induced drag on the same graph. Total drag is simply both types of drag added together vertically on the graph.

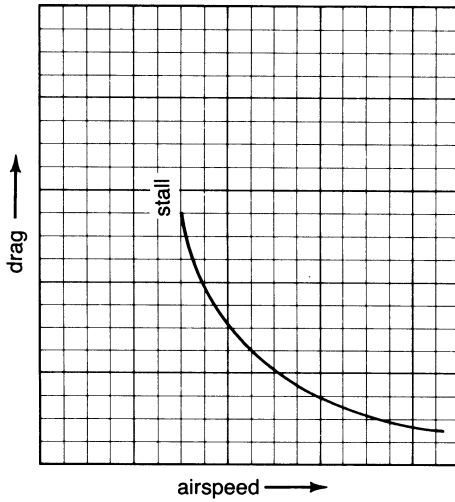

Figure 11. Induced Drag versus Airspeed

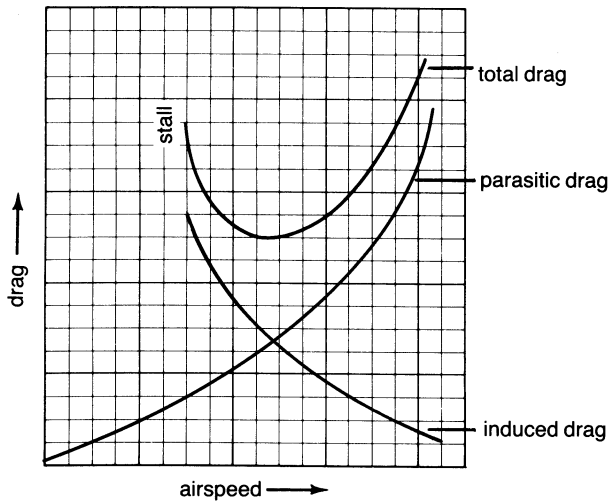

Figure 12. Total Drag versus Airspeed

This graphically-illustrated concept of total drag is important for proper aircraft control. Since you need thrust to oppose drag, think of the vertical axis as required thrust rather than drag. You'll note that at airspeeds below the minimum drag point, more power is needed to sustain level flight than at the minimum drag point. Flying at airspeeds below the minimum drag point can cause problems for the novice pilot. We will return to this curve again during Flight Lesson 4 while practicing slow flight.

Weight

Weight is an obvious concept to understand. Passengers, baggage, fuel and oil all have weight, and this weight affects aircraft performance since more lift is required to carry more weight. Look at the loading table of your Cherokee Archer (Table 1) to get an idea of how much weight and lift are involved.

Basic aircraft weight	1590 lbs.
Pilot and passengers	510
Fuel (48 gal @ 6 lbs/gal)	288
Baggage	162
TOTAL WEIGHT	2550 lbs.

Table 1. Loaded Cherokee Archer Example

Thrust

Thrust is created by your engine and distributed by your propeller. The propeller is an airfoil that creates lift by the same principles previously discussed in the **Lift** section. The major difference between propeller and wing theory is that a propeller rotates to move its airfoil, thus complicating the concept of relative wind.

Our discussion of thrust production will be quite simplified and will not include the nuisance turning forces which are byproducts of thrust production. We will also skip discussions of propeller efficiency, the effects of which are quite transparent to the user of FS2.

One important facet of thrust production will be quite apparent to you; thrust is not proportional to RPM as read on the tachometer. Again, the dynamic pressure of air is a function of the square of velocity, making a slight increase in RPM more thrustworthy at higher RPMs.

Table 2 is a Power Table for your aircraft. Note that equal incremental power changes at higher power settings are obtained with smaller differences in RPM. You will find that most of your inflight power settings will be within the 1800 to 2600 RPM range. Table 2 clearly illustrates that this small range encompasses great changes in percentage of power output. While its engine is not perfect, the 64K version of FS2 does exhibit this phenomenon.

% Power	RPM	Change in RPM
45	2040	—
50	2160	120
55	2265	105
60	2360	95
65	2445	85
70	2525	80
75	2580	55

Table 2. Cherokee Archer Power Table (6,000 ft. altitude)

Stability

Stability in terms of aircraft control defines the ability of an aircraft to return to a normal-state attitude, unassisted by the pilot, after it is displaced from that normal state. If you change aircraft attitude and the aircraft maintains that attitude when you let go of the controls, you've encountered *neutral stability*. *Negative stability* is experienced if you change attitude and the attitude continues to change in the same direction after you've let go of the controls. Finally, if the aircraft is in a steady state and your controlled displacement is followed by the aircraft's return to its original state, you've experienced *positive stability*.

Aircraft pitch and yaw stability are classically explained by comparing the aircraft to an arrow. The tail feathers of an arrow tend to exert increased

pressure if the arrow is not aligned with the relative wind. This extra drag on the rear of the arrow causes the arrow to align itself with the wind as pressure is applied behind the center of mass.

Balance and Pitch Stability

For safety reasons, aircraft must demonstrate positive pitch stability before they can be certified. Correct balance ensures positive pitch stability, at least in the static (one point in time) sense. If your loaded aircraft's center of gravity is ahead of the center of lift, the aircraft usually has positive static pitch stability. This is because center of lift roughly equates to center of pressure (as per the arrow example).

More important than this (very condensed) discussion of stability is the consequence of pitch stability on aircraft control. Figure 13 shows a stable loading condition, with the aircraft's center of gravity ahead of its center of lift. Imagine that the CG and CL vectors are strings; pulling them would cause the aircraft to pitch down. In fact, tail down force is needed to keep the nose from dropping. This tail down force is present during most of your flights in the Cherokee Archer.

Applications of power have surprising effects as the force of the propeller's slipstream exaggerates tail down force. In Flight Lesson 1 you will find, assuming no pitch intervention on your part, that an increase in power causes the nose to rise and airspeed to decrease. A decrease in power causes the nose to drop and airspeed to increase above your present cruise speed.

Positive pitch stability has great implications for easy aircraft control. Understanding the stable-pitch nature of aircraft will help you avoid over-reacting with pitch control. Figure 14 illustrates aircraft pitch oscillations assuming positive dynamic stability. Pilot over-reaction in pitch is usually caused by overenforcing pitch changes in the direction that your aircraft wants to pitch anyway. Good pilot reaction involves a knowledge of these oscillations, and requires application of pitch control opposite to the natural direction a bit before the aircraft passes through the desired pitch attitude.

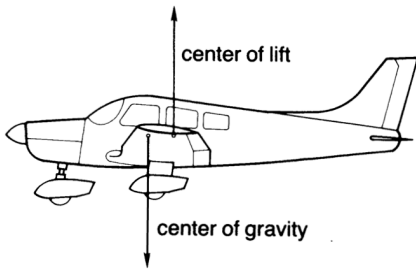

a) . . . imagine pulling these strings

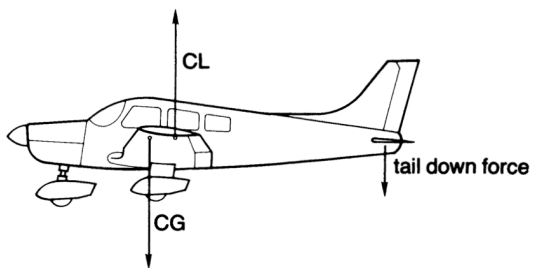
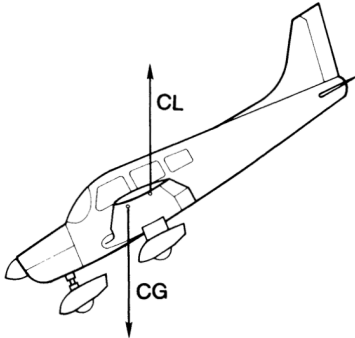

b) tail down force balance

Figure 13. Stable Loading Condition

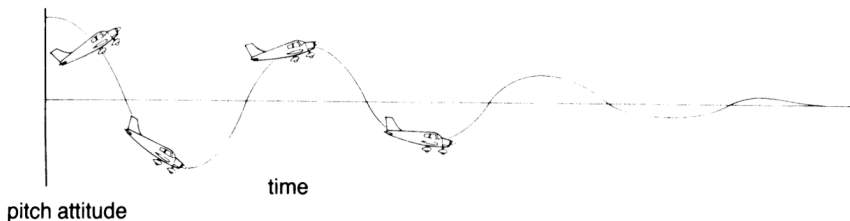

Figure 14. Positive Dynamic Pitch Stability

Roll Stability

Positive roll stability is not a requirement for aircraft certification. Like pitch stability, a knowledge of roll stability will help with your aircraft control.

Roll stability is commonly positive in shallow banks, neutral in medium banks, and negative at steep bank angles. The FS2 provides slightly positive roll stability at any bank angle; this means that the aircraft will always tend to roll level out of a bank with no control displacement on your part.

The Flight Controls

Flight controls allow you to change the aircraft's orientation about the pitch, roll, and yaw axes as well as change the amount of thrust and drag on the aircraft. All flight controls obtain force through air deflection. An example of air deflection is the downwash described in the **Lift** section. The principles of deflection (that induce lift) transfer to our discussion of flight controls, except that in this case orientation of the control surface may cause local upwash, downwash, or sidewash.

The principles of air deflection are very straightforward. Figure 15 shows deflection of air by a vertical control surface mounted on the rear of the aircraft, the rudder.

Principles of lift apply to control surface wind deflection, and the effects of velocity are worth reviewing. Remember that the dynamic pressure of air is a function of the square of velocity. You can't expect aircraft control from control surfaces at zero airspeed. You'll experience sluggish control response at slow airspeeds, and good response at high airspeeds.

If you don't feel comfortable with control terminology or this axis of rotation review, please review the appropriate sections in your POH manual. Note that whenever an "elevator" reference is made, we mean "elevator" or "stabilator" depending on aircraft type. The Piper Cherokee Archer actually uses a stabilator, a one-piece moveable horizontal control surface. Consider stabilator and elevator to be synonymous; from an aircraft control standpoint their functions are identical.

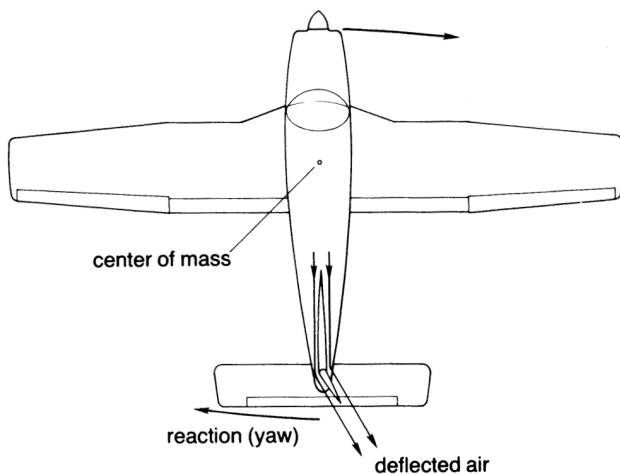

Figure 15. Deflection of Air by the Rudder

Physics of Aircraft Control

Pitch Control

Assume that your aircraft is flying at a constant altitude at cruise power. Each of the four forces balance the others perfectly.

Climb

Increased back pressure on the control yoke (up elevator) causes the aircraft to pitch up. Initially, the increased angle of attack results in excess lift causing an acceleration upward. The aircraft is now, in effect, going uphill. This extra work will slow the aircraft to the point where all forces again balance, and the aircraft will be in an unaccelerated climb. Climb rate at this new equilibrium depends on available power and pitch attitude. This concept is illustrated in Figure 16.

Note that in a steady-state climb, thrust must balance both drag and the component of weight opposing the climb. In other words, the amount of thrust in excess of that needed to balance drag will determine the climb performance of the aircraft. When all factors except thrust are held constant, more power means more climb performance.

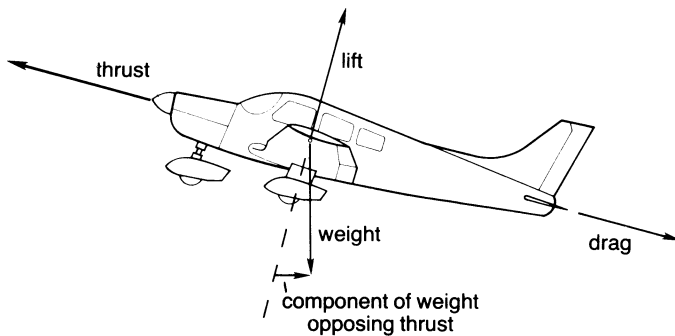

Figure 16. Steady Climb: Thrust = Drag + Component Of Weight Opposing Thrust

Summarized simply, back pressure on the control yoke (up elevator) causes the aircraft to pitch up, gain altitude, and lose speed.

Descent

Forward pressure on the control yoke (down elevator) causes the aircraft to pitch down, lose altitude, and speed up. Analysis of the descent is similar to that of a climb, except that some effects work in reverse. The equilibrium point will occur at an airspeed where drag equals thrust plus the component of weight aiding thrust (see Figure 17).

Notice that in our discussion of climb and descent, both climb rate and speed are emphasized. Pitch control can be used to vary either altitude or speed.

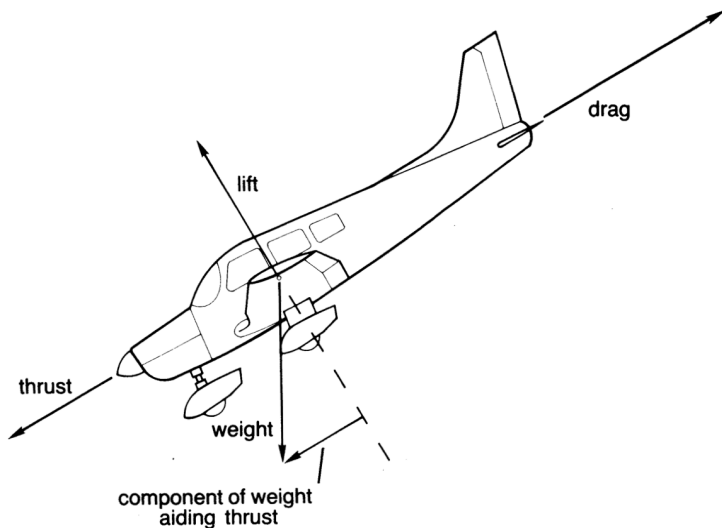

Figure 17. Steady Descent: Drag = Thrust + Component Of Weight Aiding Thrust

Roll Control

As discussed in the POH manual, roll control will change the bank angle of the aircraft. Application of left or right rotating pressure on the control yoke (left or right aileron) causes the aircraft to roll in the same direction as the application. Releasing pressure on the yoke (centering the aileron) stops the roll and maintains the bank angle obtained when the pressure was released.

An aircraft in a bank will turn (change direction). The cause of this turn is illustrated in Figure 18a.

The horizontal component of lift will pull the aircraft, and the aircraft will change heading in the direction of this pull. The classic analogy is illustrated in Figure 18b.

A full explanation of the turn is really a bit more complicated than this. As the banked aircraft begins to change its direction of movement, the nose is still pointing (at least momentarily) in the original direction of movement. The tail and other surfaces begin to act like the feathers on an arrow: the aircraft's nose changes direction as the aircraft constantly re-aligns itself into the relative wind.

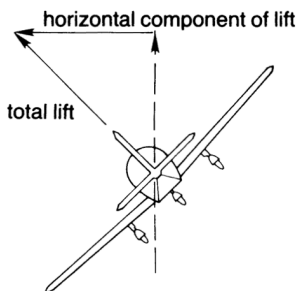

a) Aircraft in a bank

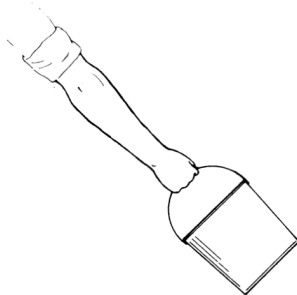

b) The classic analogy "arm swinging a bucket".

Figure 18. The Turn

Let's stop and summarize. You know that pitch can control altitude or speed. Roll is used to control heading (or change in heading).

Yaw Control

Rudder application will cause rotation about the vertical axis. Assuming that all other control inputs are held constant, the application of rudder causes a change in relative wind along the longitudinal axis.

During most aspects of flight, the purpose of yaw control is to keep relative wind aligned with the longitudinal axis. Auto-coordination mode on the FS2 applies rudder for you. Therefore, this alignment will be of little concern to you during your initial flights.

Drag (and Lift) Control

Generally speaking, the first few "notches" of flaps mostly increase lift, while the last notch of flaps adds mostly drag. Flap operations will be practiced in Flight Lesson 4.

Thrust Control

Assuming that you are in unaccelerating straight and level flight, an increase in power will cause the aircraft to nose up. This nose-up tendency is a result of the aircraft's pitch stability discussed previously. Increased dynamic pressure causes extra tail down force. If you do not counteract this tendency by pitching the nose down, the nose will rise to a new equilibrium point resulting in an airspeed lower than the level flight airspeed. The effect of stable tail down force means that a reduction in power will allow the tail to rise (and nose lower). The new equilibrium airspeed will be higher than your level flight airspeed.

As discussed in the **Stability** section, power's effects on airspeed go contrary to many preconceived ideas on power use. A change in power must be counteracted by an adjustment in pitch pressure in order to achieve the main level flight use of power, i.e. airspeed control. It is very important that you consider this stability effect, since airspeed control problems are

caused by pitch stability. Sloppy pilots who don't adjust pitch pressure during changes in power will gain airspeed during power reductions on final approach to landing. Again, only if proper pitch pressure adjustments are made will more power give more airspeed and less power reduce airspeed.

Terminology of Flight Goals

As you learn flight maneuvers, you will be given goals to achieve in heading (direction), altitude, airspeed and, often, vertical speed. The proper achievement of these goals can be measured on flight instruments as well as through outside viewing. If necessary, review the Flight Instruments section of your POH manual. The following information supplements the POH as required for the purposes of your flight lessons.

Heading

Heading conventions in the 360-degree circle system include 0 or 360 degrees for north, 90 degrees for east, 180 degrees for south, and 270 degrees for west. For practical purposes the trailing zero is omitted from heading for navigation aids shown on maps, and for runway numbers. Review the "compass rose" in Figure 12 of the POH manual.

Other important terminology with respect to heading involves changes in heading. You may be asked to turn toward a specific heading, or you may be asked to change heading by a specified number of degrees. In the latter case, be prepared to apply 360-degree arithmetic. Important 360-degree arithmetic concepts include: 90 degrees = one-quarter of a circle, and 180 degrees = one-half of a circle. An example turn request could be, "make a 180-degree turn to the right".

Airspeed

The readout of your airspeed is called *indicated airspeed*. Indicated airspeed differs from true airspeed as altitude increases. At higher altitudes the air is less dense, decreasing the amount of dynamic pressure available to drive the airspeed indicator.

While your true airspeed is higher than your indicated airspeed at higher altitudes, true stall speed is also increased. Therefore, you can safely use the same indicated airspeeds for high-altitude takeoffs and landings with approximately the same safety margin above stall speed. Your airplane will stall at nearly the same indicated airspeed regardless of altitude.

During cross-country flights, pilots usually want to calculate true airspeed. Pilots use a special calculator or a traditional flight computer (resembling a circular slide rule) to obtain airspeed corrections. You can use Table 3 to determine the correction factor.

Density altitude refers to your altitude corrected for nonstandard barometric pressure and temperature. Using indicated altitude should be adequate for the purposes of this flight simulator.

Multiply your indicated airspeed by the correction factor to obtain true airspeed.

Density Altitude	Correction Factor
0	1
1000	1.015
2000	1.03
3000	1.045
4000	1.061
5000	1.077
6000	1.094
7000	1.111
8000	1.128
9000	1.146
10000	1.164
11000	1.183
12000	1.2

Table 3. Airspeed Correction Factors

Turn Rate

Turn rate is defined in terms of a “standard rate”. The standard rate for light aircraft is three degrees per second. This is also termed a two minute turn since it takes two minutes to complete a 360-degree turn (360 degrees / 3 degrees per second = 120 seconds).

You will usually make standard rate turns during practice instrument flight. The amount of bank required to obtain standard rate varies with airspeed. The higher the airspeed, the more bank required for a standard rate turn.

Pitch and Bank Attitude

When attempting to change altitude, airspeed and heading, you must alter your pitch and bank attitudes. While the altimeter and gyro heading indicator can give you a direct reading on your flight goals, you should not make changes in pitch attitude or bank on these instruments. If your goal is to climb, you know that you have to raise pitch attitude. To change heading, you have to place your aircraft in a bank.

In summary, you understand the aircraft physics of pitch and bank, and you effect aircraft performance through changes in pitch and bank. The main instrument used in pitch and bank control is the attitude indicator.

A Summary of Flight Goals

Figure 19 shows the flight instruments grouped in a manner consistent with good aircraft control methods.

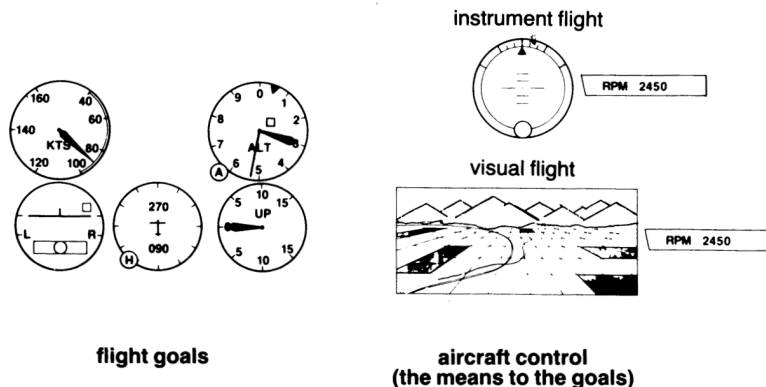

Figure 19. The Division Of Instruments Into Goal versus Control Instruments

The division of instruments into goal instruments vs. control instruments is an extremely important consideration. While there may be some argument as to which instruments belong in which group (as the turn indicator is a means to a directional goal), there can be no argument that you do not effect aircraft control through goal instruments but, rather, through the control instruments.

I'll close this section with a story that should convince you not to chase goal instruments. In the next section you'll learn how to perform normal flight maneuvers through proper use of the instruments.

A member of a local flying club was attempting to advance toward his instrument rating. He had 200 flight hours, including practice at simple instrument approaches, when he came to me requesting instruction.

I was impressed with his technical knowledge of approach procedures, yet his approaches were poor. Basic aircraft control seemed to be his problem, so we went back to the basics; instrument climbs, descents, plus straight and level flight. His basics were poor. He couldn't hold altitude within 200 feet of the assigned altitude while in level flight. He was chasing his altimeter.

I covered up his altimeter, which forced him to use the attitude indicator as a means for altitude control. After one minute I uncovered his altimeter, revealing a variation of less than 50 feet from initial altitude.

It seems ironic that his altitude control was good as long as he had no altimeter yet poor when the altimeter was restored, but this is exactly what happens if you don't learn correct basic control. After five hours of proper instruction his aircraft control started to improve. Indeed, his 200 hours of improper aircraft training had developed bad habits which proved nearly impossible to break.

The Basic Flight Maneuvers

Information Scan

To effect proper control through flight instruments and visual clues, you have to develop a good information scan. Figure 20 illustrates a good sequence

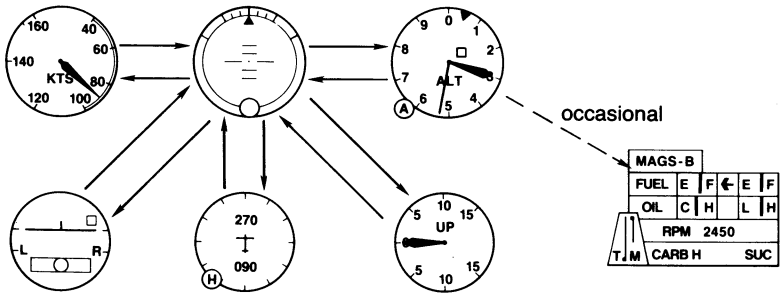

a) instrument flight

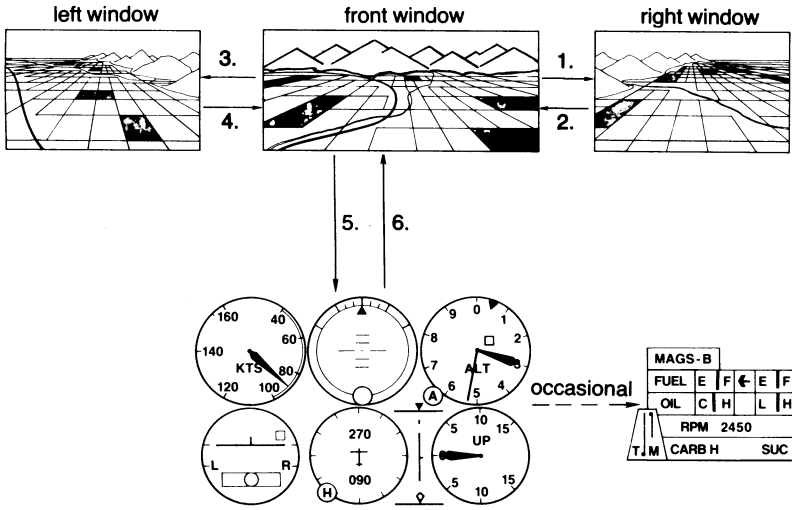

b) visual flight

Figure 20. A Scan Sequence for Aircraft Control

to follow. Since power remains rather fixed, the tachometer is included only occasionally in the scan. Don't construe "occasionally" to mean secondary but rather just less often, say once every 30 seconds.

Note that in the top diagram (instrument flight) the attitude indicator becomes the central hub of viewing activity. Since you effect aircraft control toward a goal through the attitude indicator, its central nature is obvious.

Time spent looking at any one instrument should be long enough to ensure correct interpretation of the instrument. Don't rush it.

The visual scan (bottom diagram) ensures that you will look for traffic while flying. There are pilots guilty of not looking out the window during visual flight. Apparently they assume that there's plenty of room in three-dimensional space and the probability of collision with another aircraft is small. Over time, probability can catch up with you. I fondly remember 2303S, a Cessna 150 that I flew in 1968. One pilot stuck it into the right side of an airliner approaching Milwaukee. He forgot the critical nature of step #3.

You may question your ability to maintain aircraft control while looking outside the plane. The wings and nose can provide you with the same information the attitude indicator gives, once you've learned to interpret their orientation. After all, the attitude indicator only simulates actual physical orientation.

Unfortunately, flight simulation lacks transfer to real visual flight. Remember to have your instructor force you to develop a good visual scan should you start flying real aircraft.

Bank Control

Straight Flight

During straight flight the obvious goal of bank is to keep a constant heading. Don't fixate on the heading indicator, as such activity will lead to chasing the indicator. Like most aircraft control activity, you should use the attitude indicator or natural horizon as a means to control heading. If you notice that you're off your assigned heading, enter a shallow bank on the attitude indicator or natural horizon. Cross-check heading during the scan and rollout using the attitude indicator or natural horizon.

Standard Rate Turn (instrument flight)

Standard rate turns are entered on the attitude indicator. Roll the aircraft in the desired direction. Cross-check with the turn indicator during your scan. Once the standard rate is achieved, neutralize ailerons and note the bank required to maintain that rate. Keep in mind that the required bank increases with increases in airspeed. Cross-check with the gyro heading indicator, as your goal is to rollout on a newly assigned heading. You should begin rollout before the desired heading is reached. A good rule of thumb is to begin rollout the number of degrees before desired heading equal to one-half your bank angle. If this rule doesn't work well for you, just increase or reduce your aileron pressure (rollout rate) until it does work. If you can't maintain good roll control with an increased roll rate when flying FS2, then start your rollout earlier.

30-Degree Bank Turns (visual flight)

While standard rate turns are desirable for instrument flight, they are much too slow for visual flight. During a turn you usually have one wing blocking your view of possible traffic, so it is desirable to complete the turn quickly.

The method for entering and exiting 30-degree bank turns is the same as for standard rate turns except that your goal during the turn is 30 degrees of bank rather than standard rate. The attitude indicator is the goal instrument as well as the primary control instrument during the turn.

Pitch Control (visual flight)

The FAA issued a bulletin in the mid-1970s in an attempt to simplify the teaching of pitch control. They proclaimed that when power is fixed, pitch controls airspeed. When power is variable, pitch controls altitude or change in altitude.

Power is fixed only during climbs (at full power in most training aircraft) or during maximum rate descents. Power is variable during cruise level flight, airspeed transitions, or cruise descents.

There will always be arguments as to whether pitch or power controls altitude or airspeed during specific maneuvers. If you observe a professional

pilot's technique, you won't be able to tell what inputs are controlling which goals. You will, however, find it necessary to separate the uses of pitch and power until your flight control technique becomes automatic.

Level Flight

During level flight you will use pitch to control altitude and power to control airspeed. If you notice that you are low, pitch up slightly. If you are high, then pitch down accordingly.

Control airspeed with power. If your airspeed is low then add power, and vice versa. Changes in pitch will affect airspeed and changes in power will affect altitude, but you must separate the uses of pitch and power to obtain control. If you change pitch attitude and hold this attitude constant, you've simplified a set of flight equations. In most cases, after the aircraft stabilizes at a new equilibrium only one rate of climb and airspeed can result.

The concept of holding pitch or power constant is very important. Note that to hold pitch constant, you will have to vary pitch pressure as the aircraft changes speed. If you're careful to hold a constant pitch, the aircraft will settle to its new equilibrium. Once you've determined the resulting equilibrium, you may need to estimate (and readjust) the pitch as required for any desired change in altitude (zero change for level flight).

Just use your common sense in maintaining a level flight pitch attitude. If one pitch attitude causes a climb and another causes a descent, then the zero-climb pitch attitude must be somewhere in between.

When you're within 100 feet of your assigned altitude, corrective pitch changes will be small and airspeed changes minor enough to be ignored. If you're more than 100 feet off from your assigned altitude, the required pitch change may be too great. You will then have to use a climb or descent, with power change, to correct your altitude.

Climbs

The climb is broken into three separate components; entry, constant climb, and level-off.

Entry: Assuming normal cruise flight, a climb is initiated by pitching the aircraft nose up. After this change in pitch, add full power. Remember, pitch then power. Power before pitching does little to aid the climb and you may redline engine RPMs due to lack of resistance. The only exception to pitch then power may be when transitioning to a climb from slow flight.

Constant Climb: At full power, use pitch to control your airspeed. Remember to hold pitch constant and wait for the resulting airspeed, then adjust pitch according to your estimate of the pitch required to obtain the desired airspeed. Nose up for less airspeed, nose down for more. The desired airspeed may be best angle of climb to clear obstacles, best rate of climb, or cruise climb airspeed for better engine cooling. These airspeeds for the Piper 181 are 64, 76, and 87 kts respectively.

Level Off: Just before reaching your new assigned altitude, nose down gradually to intercept the altitude. The FAA recommends you start level-off at 10% of your vertical speed before the desired altitude. If vertical speed is 500 feet/minute, for example, you should start your level-off 50 feet before the target altitude is reached. At this time altitude again becomes the goal of pitch control. Power will again control airspeed. Hold power full until you reach cruise speed (approximately 130 kts indicated) and then reduce power to cruise setting.

Cruise Descents

Like a climb, the descent is broken into three components; entry, steady descent, and level-off.

Entry: The pitch-power order is opposite of that required for a climb, power then pitch. Reduce power 500 RPM and then adjust pitch to control vertical speed. The 500 RPM reduction is really just a starting point. Generally speaking, a good goal for your vertical speed is 500 feet/minute. During the descent, adjust power to hold cruise airspeed.

Steady Descent: You should note that the change in pitch attitude required for a descent is less than that required for a climb. Note also that you must add slight pitch up pressure to obtain the correct nose down attitude for the desired descent rate, due to the pitch stability of your aircraft discussed previously.

Level Off: As you approach your new assigned altitude, increase throttle to cruise power and then pitch to hold a constant altitude. The 10% rule (of vertical speed) works well for level-offs from both climbs and descents.

Slow Descents

Slow descents are usually used during landing approaches, a necessary part of any successful flight. Your final approach speed will be 70 kts. We apologize to the FAA for deviating from their pitch-power rule, but during slow descents most instructors advise using pitch to control airspeed and power to control vertical speed (glidepath for landing).

During slow flight, pitching up will not affect vertical velocity much, since your airspeed is nearing the point where less pitch means more drag (re Figure 12). Pitching up to stretch a glide may get the inexperienced pilot into trouble as airspeed drops below a safe level.

If you need to reduce vertical speed (in order to stretch a glide), add power while you increase pitch slightly in order to maintain airspeed. If you need to increase vertical speed (reduce glide range), decrease power while lowering pitch to maintain airspeed.

Airspeed Transitions

You will need to slow down, and possibly speed up, your aircraft when adjusting to traffic flow on entering an airport traffic pattern. Consider a slow speed in your light aircraft to be 90 kts with 10 degrees of flaps. Cruise speed (120 kts) can be considered fast.

During all airspeed transitions, altitude control will be the goal of pitch with airspeed the goal of power. Starting at cruise airspeed, decrease power below 1800 RPM. As the aircraft slows, adjust pitch to maintain altitude. Once below the maximum flap extended speed of 102 kts, extend 10 degrees (one notch) of flap. As the airspeed nears 90 kts add power (adjust power) to maintain 90 kts.

To accelerate back to cruise airspeed add full power. Adjust pitch to maintain altitude, and remove flaps. As the aircraft approaches cruise speed, reduce throttle to cruise power.

Takeoffs

Note your takeoff time on paper, and then line up with the runway centerline. Smoothly apply full throttle. As the aircraft accelerates to the rotation speed of 55 kts, pitch up 9 degrees (initially). Adjust pitch to maintain best rate of climb (76 kts) for 400 feet, and then lower your pitch attitude to 7 degrees to establish a cruise climb of 87 kts.

Section Two – Beginning Flight Lessons

As stated in the **Introduction**, these flight lessons are designed to teach you correct methods of flight control. The implications of the early learning of bad flight control habits go beyond just the subsequent difficulty of unlearning those habits. In times of anxiety (emergency), you tend to revert to your early learning. Acquiring proper pitch control and instrument scan techniques is so important that flight instructors remind their students of the proper control procedures very often during the first flight lessons. Such reminders are seldom included in educational texts, but I feel obligated to constantly repeat these important concepts. Please bear with me when you see the phrase *\$pitch control-scan* repeated often throughout the text. Also, remember to include engine and fuel gauges occasionally in your scan.

Please remind yourself that when we say “establish a pitch attitude”, we mean pitch attitude and not elevator position. You must vary elevator position to keep a constant pitch attitude until the aircraft stabilizes. Once you’ve internalized where to place your pitch attitude for different airspeeds, power settings, flap positions, bank angles, and aircraft weights (in a real aircraft), then you will have mastered aircraft control.

Since the FS2 does not carry all the equipment found in a real Cherokee Archer, pre-takeoff, in-flight, and before-landing checks are lightly covered. Nevertheless, these checks should be performed simply to establish good flight habits.

Pre-takeoff preparations will be covered in Lesson 1. The following symbols, covering other checks, appear throughout the text:

\$GHI: Check or set heading indicator. While this manual places this symbol at periods related to maneuver practice, the FAA advises you to check the GHI against your compass at least every 15 minutes. In your training mode the compass and GHI will always agree, but you should still develop the habit of checking both periodically.

\$fuel tank-mixture-carb heat-altimeter: This (incomplete) pre-landing check list is accomplished as follows:

fuel tank – set on fullest tank (CTRL F, < or >)

mixture – rich (CTRL M, >)

carb heat – check for 5 seconds, then turn off
(CTRL I, wait 5 seconds, CTRL I)

altimeter – set to current setting (CTRL B)

When going through the lessons, be aware that fatigue will reduce your performance. You may find yourself tiring after only 30 minutes during the initial flight lessons. Take a break.

When starting a new flight lesson, read several paragraphs ahead before beginning maneuver practice. Often a maneuver request is followed by an explanation of the maneuver. You may also wish to pause the simulation (press P) at certain points.

The following abbreviations (as well as **Section One** abbreviations) are used in this lesson section:

- AGL – above ground level
- CDI – course deviation indicator
- CMI – identifier for Champaign Willard Airport
- DME – distance measuring equipment
- FPM – feet per minute
- MDA – minimum descent altitude
- MSL – mean sea level (altimeter reading). If an altitude is not labelled, assume MSL.
- NDB – non-directional beacon
- OBS – omni-bearing selector
- WCA – wind correction angle
- VOR – very-high-frequency omni-range (your main navigation radio)

NOTE: Some training mode features are only available with 64K of memory. In addition, alternate speed and power settings required for the simple 48K (Apple II or Atari) engine appear in parentheses following the normal 64K values.

Flight Lesson 1

- taxiing
- pre-takeoff preparations
- takeoff and level-off
- power changes and pitch stability (self demo)
- climbs and descents
- instrument takeoff, climbs and descents

limits:

altitude: +/- 150 feet

airspeed: +/- 10 kts

Press ESC (E key on C64) to enter the editor, select User Mode 8, and then ESC (or E key on C64) back to flight mode. Mode 8 starts you off at the University of Illinois, Willard Airport, where you will be taking your flight sessions. Three level lines should appear on the window. They are to be aligned with the horizon during initial learning of pitch control. The top, middle, and bottom level lines, 0 degrees, 7 degrees, and 9 degrees, represent approximate pitch attitudes for level flight, cruise climb and best rate of climb respectively. The angled lines are for finding 30-degree banks in level flight.

Elevator Control

The bulk of Flight Lesson 1 concerns pitch control. As stated in the **Aircraft Control** section of the POH, precision elevator control in a keyboard-operated flight simulator requires a "micro-adjustable" elevator. Practice rapid vs. slow keypresses of the B and T keys. Note that slow keypresses give you fine control. Your elevator position changes slightly after every keypress even though the position indicator changes only once every two keypresses.

Taxiing

Press the 4 key, and then press the < key several times. Press the > key a few times, then use both keys to set up a good full view of Willard Airport. Press the 5 key to return to forward view. The simulator will stay at the same radar-view altitude after you've gone back to forward view; you may wish to return to this radar view periodically while taxiing.

Study the control keys outlined on the FS2 Flight Reference Card. Familiarize yourself with the throttle, rudder, and brakes before attempting to taxi. Add one keypress of throttle, followed by full rudder in either direction; you should find yourself turning circles. Note changes on the heading indicator. Switch between radar and window view.

If you want to stop on a specific heading, just press G when that heading is reached. Stop your turn at a heading close to 180 degrees.

Add three keypresses of throttle and let the aircraft move straight ahead. After ten seconds drop back to zero throttle. Press the SPACE BAR (and REPT key on the Apple II plus), and hold until you come to a stop.

Use your front view, radar view, and Figure 21 to taxi to the beginning of runway 31. If you get lost you can ESC (E key on the C64) to the editor, change to User Mode 0, ESC, change back to mode 8, ESC, and then ESC back to flight mode. This resets the mode parameters and takes you back to your original starting point.

The compass rose in Figure 21 should help you taxi around Willard Airport. Note that you need a heading of 090 degrees for a few feet to intercept the outer taxiway. Turn to a heading of 145 degrees, and follow the outer taxiway in a left circle. Once on the southeast taxiway, use a heading of 136 degrees. At the end of the southeast taxiway, a right turn to 220 degrees followed by another right turn to 315 degrees will put you at the beginning of runway 31.

Maneuver to set a heading of exactly 315 degrees. (If you can't find runway 31, just head to 315 degrees to get ready for takeoff.) Stop (SPACE BAR). In reality you would seldom stop to get organized on a runway, but in the case of FS2 there are no other aircraft to hit you.

Pre-Takeoff Preparations

Your preparation consists of only four items:

1. Neutralize flight controls,
2. Set navigation radios,
3. Understand your departure heading and level-off altitude, and
4. record (write down) your takeoff time.

Control and system checks will not be covered. We will skip preparation steps 2 and 3 for the first two lessons.

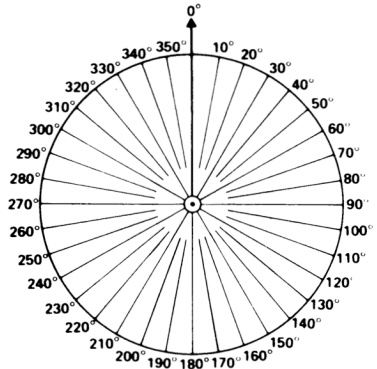
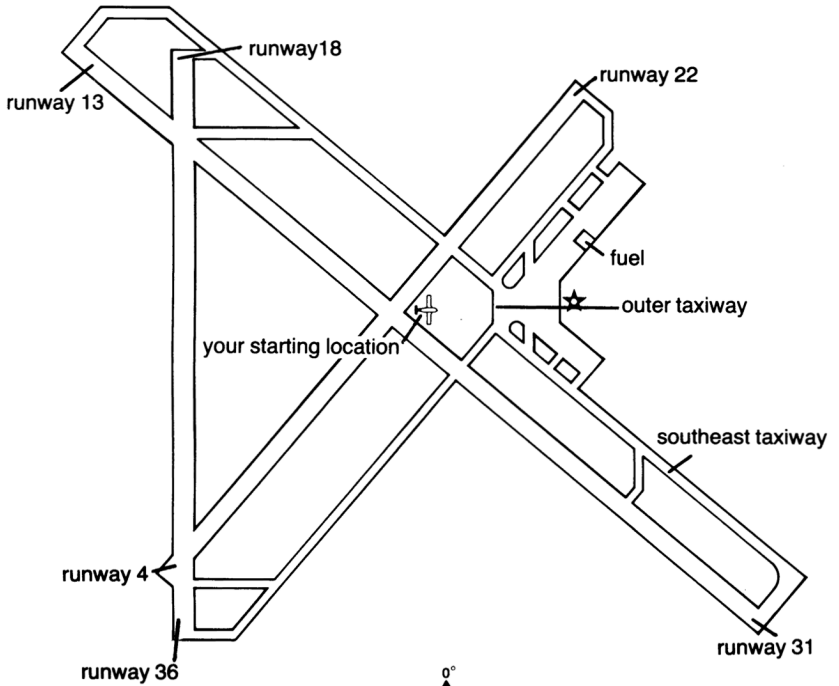

Figure 21. Taxi Chart of Willard Airport

1. Set elevator, ailerons, and elevator trim to neutral. Set flaps to zero (up). If you have trouble reading the flap position indicator, just press the Y key four times to make sure your flaps are up.
4. Record the current time.

Takeoff and Level-off

NOTE: Only pitch and power control will be covered in this lesson. Please avoid pressing aileron or rudder keys during this lesson.

Apply full throttle by repeatedly pressing the "MORE THROTTLE" key. Never use the / key (full or cut), as such a rapid throttle application could cause a real aircraft engine to fail. Allow the aircraft to accelerate to 55 kts, then press B rapidly 3 times. The aircraft will rotate and lift off. Your task is to establish a pitch attitude for the best rate of climb speed (76 kts). This pitch attitude should be close to an attitude where the natural horizon is on the bottom window line.

Once you pass through 1150 feet MSL (400 feet AGL), apply a little down elevator (T key) and establish a new pitch attitude that gives you an 87 kts cruise climb speed. The horizon should be close to the middle window line. \$pitch control-scan.

You will level out at 4500 feet. At 4400 feet, lower pitch smoothly to a level flight pitch attitude (top window line). The goal of your pitch attitude is now altitude control. Modify pitch attitude as necessary to hold 4500 feet. Keep full power to help you accelerate to cruise speed. Once airspeed reaches 130 (125) kts, throttle back to 2250 (2600) RPM.

Use elevator control for two or three minutes to maintain 4500 feet. Learn the difference between over-reaction and under-reaction. Once level, the aircraft should be fairly stable. Occasional *small* pitch adjustments will be necessary to maintain altitude. \$GHI

Power Changes and Pitch Stability*

If the aircraft is level at 4500 feet with only occasional small pitch adjustments necessary, try the following self-demonstration of the effects of power changes on pitch:

* Later versions of FS2 do not include the more power/less airspeed effect in order to make the simulation easier to fly.

Reduce throttle to approximately 2000 (1600) RPM (don't touch any other controls). Note that while airspeed decreases at first, in the long run your new equilibrium airspeed is higher than cruise speed. Therefore, you will need to use a little up elevator to maintain cruise speed during a descent.

While descending through 2500 feet, add full power. Note the opposite effect. Take over pitch control and level off at 4500 feet.

Climbs and Descents

Review the pitch-power order and control responsibilities for climbs and descents on pages 43-44.

Descend at your cruise airspeed of 130 (125) kts to 2500 feet. To enter the descent, reduce power to approximately 1800 RPM. You will have to pitch down initially, followed by up elevator to keep airspeed from rising above cruise speed. Note the relatively small difference in pitch attitude from level flight. At 2600 feet, increase power to 2250 (2600) RPM cruise power, and begin your level-off to a level pitch attitude. Hold 2500 feet.

Now climb to 4500 feet. Pitch for the cruise climb speed of 87 kts, then add full power. During your level-off, remember to keep full power until the aircraft has accelerated to cruise speed. \$GHI

Repeat climbs and descents until you're satisfied with your airspeed and altitude limits.

Instrument Takeoff, Climbs and Descents

ESC to the editor, set User Mode to 9, and ESC back to flight mode. You will be back on the ground under cloudy conditions with full flight instruments. Taxi to runway 31 (or just head 315 degrees). Perform preparatory steps 1 and 4.

Note the horizontal lines on the attitude indicator. These lines are placed at 10-degree increments (5 degrees is standard in real aircraft). During takeoffs, climbs, and descents, you will use these lines for your pitch goals. Again, suggested starting pitch attitudes are 9 degrees for best rate of climb, 7 degrees for cruise climb, and zero degrees for level flight.

After takeoff you will enter the clouds. Review takeoff, level-off, descents, and climbs on instruments.

Flight Lesson 2

airspeed transitions
turns
instrument turns

limits:

altitude: +/- 150 feet
airspeed: +/- 10 kts
rollout heading: +/- 15 degrees

Set User Mode to 8, taxi to runway 31, and perform preparatory steps 1 and 4. Takeoff and level off at 4500 feet. Practice climbs and descents if you think you need the review.

Airspeed Transitions

Slow to pattern/approach speed and configuration while holding altitude steady at 4500 feet. Your goal speed should be 90 kts. Configuration will be one notch (10 degrees) of flaps. Review pages 35-36 on airspeed transitions.

Pitch control-scan. This is another exercise in thinking ahead of the aircraft. Reduce your power slowly to nothing. As speed drops, the angle of attack must increase to maintain lift. As airspeed drops below 102 kts (top of the white/flap range arc on the airspeed indicator), press N once to add 10 degrees of flaps. Pitch down to offset the flap-pitching moment. As airspeed slows, increase power to maintain the goal airspeed of 90 kts. Note your final pitch attitude.

To transition back to cruise speed, add full power and then retract flaps (Y key) back to zero. Don't delay your flap retraction. **Pitch control-scan.** Use pitch to effect altitude control. As in the level-off from a climb, keep full power until the aircraft has accelerated back to cruise speed and then reduce power to cruise RPM. **SGHI**

Turns

Remember that the aircraft changes bank as ailerons are applied. Once you've reached the desired bank angle, neutralize ailerons (G key). Your aircraft will keep itself in the bank. Since the FS2 has slightly positive roll stability, occasional aileron use is required to re-steepen the bank during turns of long duration.

Review turns on page 41. Note that the level attitude line on your windscreen has two angle marks attached. When an angle mark parallels the horizon, you've achieved a 30-degree bank.

While you already know that pitch attitude must be increased slightly in a bank to hold altitude, your challenge now is to determine when and how much up elevator should be applied. (WARNING - A common mistake is forgetting to apply down elevator as you roll out of the turn.)

Hold altitude at 4500 feet during the following turns:

Make a 360-degree turn to the right (one complete circle).

Make a 360-degree turn to the left.

Make a 180-degree turn to the right. If you're not sure of the correct rollout heading, just note the reciprocal heading (180 degrees/opposite) on the bottom of your heading indicator before entering the turn.

Make a 180-degree turn to the left.

Turn left to a heading of 180 degrees.

Turn right to a heading of 270 degrees.

Turn left to a heading of 240 degrees. A common mistake is to overshoot the desired new heading. This is one case where the 30-degree visual bank rule should be violated. Use small banks for small changes in heading.

Turn right to 315 degrees. \$GHI

Review airspeed transitions and turns (instrument).

ESC to the editor. Select Mode 9, and set altitude = 4500, pitch = 0, heading = 315, airspeed = 125, and throttle = 2700. Set Cloud Layer 1 tops to 6000 feet with a base of 1200 feet. ESC back to flight mode. Review airspeed transitions.

Instrument Turns

Review standard rate turns on page 41. Make standard rate turns for the maneuvers just performed instead of 30-degree bank turns. Note that the center dot at the level line on the attitude indicator can help you judge your pitch attitude in a turn.

Flight Lesson 3

climbing and descending turns
airspeed transitions in turns
vertical speed control in descents

limits:

altitude: +/- 150 feet
airspeed: +/- 10 kts
rollout heading: +/- 15 degrees

Taxi to runway 31 and perform preparatory steps 1 and 4. Takeoff and level off at 4500 feet. Review climbs, descents, airspeed transitions, and turns as necessary.

Climbing and Descending Turns

These maneuvers may be a bit more challenging:

Climb to 5500 feet while making a 360-degree turn to the left. Enter the turn first, then the climb. The turn and climb may or may not end at the same time. Reverse your entry order occasionally during practice.

Descend to 4500 feet while making a 360-degree turn to the left.

Climb to 5500 feet while making a 360-degree turn to the right.

Descend to 4500 feet while making a 360-degree turn to the right. \$GHI

Repeat climbing and descending turns until your altitude, airspeed, and rollout headings are within limits.

Airspeed Transitions in Turns

Begin your turn, then your airspeed transition. Reverse the order occasionally during practice.

Make a 360-degree turn to the left while slowing to pattern airspeed and configuration.

Make a 360-degree turn to the left while transitioning back to cruise flight.

Make a 360-degree turn to the right while slowing to pattern airspeed and configuration.

Make a 360-degree turn to the right while transitioning back to cruise flight.
\$GHI

Repeat airspeed transitions in turns until your altitude, airspeed, and rollout headings are within limits.

Vertical Speed Control in Descents

Until now, you've practiced descents without regard to descent rate. Now that you're getting used to more complex maneuvers, it's time to practice varying pitch and power control to vary descent rates. Mastering these techniques will improve your landing approaches as well instrument-approach descents.

\$pitch control-scan. Due to the lag in your vertical velocity indicator, these maneuvers are perhaps the best exercise for establishing a constant pitch attitude (not elevator position). If you let pitch wander or begin to chase vertical speed, you'll have control problems.

The following maneuvers involve constant descents. As your altitude drops to 2500 feet you should enter a climb, remove flaps, level off at 6500 feet, and continue practicing. You may wish to set altitude to 6500 feet in the editor instead of taking the time to climb:

Slow to pattern/approach airspeed and configuration while holding altitude. Now, begin a descent at 500 feet per minute (FPM).

Pitch for a 1000 FPM descent. Adjust power to maintain 90 kts.

Pitch for a 300 FPM descent. Maintain 90 kts.

Add a second notch of flaps (25 degrees). Descend at 500 FPM. Adjust power for 80 kts.

Pitch for 100 FPM. Adjust power to maintain 80 kts.

Pitch for 0 FPM (level flight). Hold 80 kts.

Pitch for 300 FPM. Hold 80 kts.

Add the third notch of flaps (40 degrees). Pitch for 500 FPM descent. Adjust power for 70 kts.

Pitch for 200 FPM descent. Maintain 70 kts.

Pitch for 1000 FPM. Hold 70 kts.

Pitch for 0 FPM. Hold 70 kts. \$GHI

You may want to practice the last set (40 degrees flaps, 70 kts) while reversing pitch and power goals.

Review maneuvers on instruments. ESC to the editor. Select Mode 9 and set altitude = 4500, pitch = 0, heading = 315, airspeed = 125, and throttle = 2700. Set Cloud Layer 1 tops to 6000 feet with bases at 1200 feet. ESC back to flight mode.

Review climbing/descending turns, airspeed transitions in turns, and vertical speed control on instruments. NOTE: The bank required for standard rate turns will lessen as you slow down.

Flight Lesson 4

VOR departure
flap operations
slow flight
VOR arrival
airport pattern entry

limits:

altitude: +/- 150 feet
airspeed: +/- 10 kts
rollout heading: +/- 15 degrees
course: +/- 2 miles

Review VOR and DME navigation in **The “World” and World Navigation** section of the POH. Review radio controls in the **Secondary Aircraft Controls** section as well.

VOR Departure

Set User Mode to 8 and taxi to runway 31. Perform steps 1, 2, 3, and 4 of pre-takeoff preparation:

1. Neutralize controls and trim, set zero flaps.
2. Set NAV radio to 110.0 (Champaign VOR). Even though it's already set, use CTRL N, >>> . . . to go all the way through the channels. Use CTRL N, <<< . . . keypresses to go all the way around in the other direction. Then try CTRL N, CTRL N, >>> and <<< keypresses.

CTRL V, >>> and <<< . . . to set OBS top readout of the VOR to 270.

3. You are going to takeoff from runway 31. After you reach 1750 feet MSL, start a left turn to 240 degrees to intercept the 270-degree radial from Champaign VOR. As the needle (course deviation indicator) begins to center, turn to a heading of 270 degrees to track the 270-degree radial (since there is zero wind). See Figure 22.
4. Write down your approximate takeoff time.

Mastering VOR navigation requires the correct frame of reference; when the needle shows LEFT, for example, it does not mean that you should turn left. It indicates that you should take a heading to intercept your course, a heading left of the omni-bearing selection. Over time you will internalize the art of choosing an intercept heading, but for now (with no winds) choose a 30-degree intercept. Consult the compass rose in Figure 22 when in doubt of the correct heading to choose.

If you have a 64K system, press the Q key and choose option A to begin recording your course. Review preparation step 3, then begin your takeoff. Level-off at 4500 feet.

Did your aircraft control suffer during the VOR departure? Please keep aircraft control #1 on your list of priorities. Good aircraft control will improve your navigation over the long run.

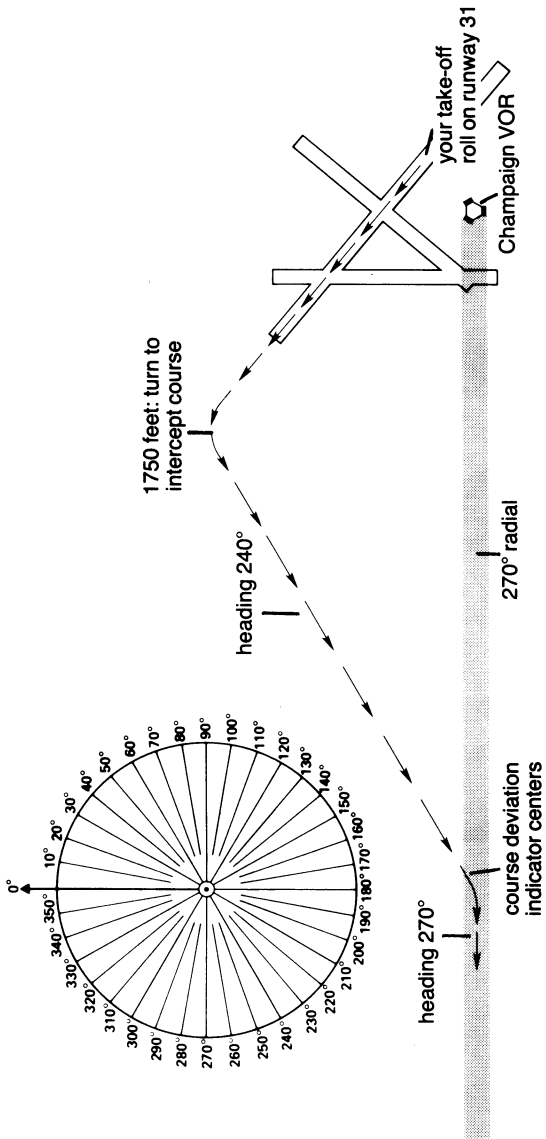

Figure 22. VOR Navigation Departure

Did you overshoot your 240-degree intercept heading? Did you overshoot the 270-degree radial from Champaign? Do you constantly overshoot the desired heading due to using too large a bank for a small change in heading? All of these mistakes are normal. Since you are not sitting next to a real, live flight instructor, try to remember your most common mistakes each time you review and perform the maneuver. Nothing is more frustrating than making the same mistake time and time again.

If you've activated the course recorder (64K option), press Q and then choose option B to view your (smoke trail) course plot. Press any key to return to flight mode.

Flap Operations

Do an airspeed transition to pattern airspeed and configuration while holding altitude at 4500 feet.

During the following maneuvers power will be fixed at either zero or full. Pitch will be used to control airspeed:

Reduce power to zero throttle, let the aircraft descend, and find the pitch attitude that holds 90 kts.

Add a second notch of flaps (25 degrees) and find the pitch attitude that holds 80 kts.

Add a third notch of flaps (full flaps/40 degrees) and pitch for 70 kts airspeed. This will be your final approach speed and configuration just before landing flair.

Now, add full power and pitch to hold 70 kts. Reduce one notch of flaps every ten seconds until you've reached zero flaps. During the flap reductions, pitch to maintain 76 kts (best rate of climb) speed. You've just performed a "go-around", a life-saving maneuver if done correctly. A go-around is often necessary just before landing if you find yourself in a poor final approach setup, or when unexpected traffic appears on the runway.

Climb back up to 4500 feet and turn to a heading of 180 degrees. \$GHI

Slow Flight

Reduce throttle to zero and pitch to maintain 4500 feet. As soon as your airspeed drops below the maximum flaps-extended speed of 102 kts, smoothly apply full flaps. As airspeed drops below 65 kts, add power to hold altitude. You are now on the back side of the power curve. Use power for altitude control, and pitch for airspeed control.

Slow to a stall. You will notice that the nose begins to drop uncontrollably at stall speed. Reduce your pitch and recover from the stall. Add power to get back up to 4500 feet. Keep the plane just above stall, level at 4500 feet for about one minute.

Make shallow turns in slow flight. Note the aircraft's sluggish response to your flight controls.

Add full power, wait five seconds, and then reduce flaps gradually to zero as you change pitch and power functions back to normal. The reason for this short wait is to avoid a stall or sudden drop in altitude that can result from a sudden reduction in flap-created lift. \$GHI

VOR Arrival (Finding Your Way Home)

\$fuel tank-mixture-carb heat-altimeter

Press CTRL V, >>> . . . until the course-deviation indicator needle centers on the TO indication. You will probably overshoot the correct omni-bearing selection, since the needle is heavily dampened. Just press the < key as required to re-center the needle on the TO indication.

Remember your flight priorities. Aircraft control has priority over navigation. When changing NAV frequencies, you do not have to finish the change before returning to the aircraft control scan and control inputs. Experienced pilots often have to divide their time between aircraft control and setting the NAV radio, returning to the NAV radio several times to finish the job. The FS2 has been designed to allow pitch and roll inputs while keeping the < and > keys activated during NAV radio changes.

Turn to the heading indicated on the top of the VOR indicator. Since there is no wind, this heading will take you directly to Champaign VOR located at Willard Airport.

If the indication is now off-center, take a small intercept angle in a direction toward the needle. Once the needle is nearly centered, return to the heading matching the OBS.

Note the DME indicator. The DME is automatically channeled to NAV 1, and indicates nautical miles to the station. When/if you are within 15 miles of Champaign's Willard Airport, begin a cruise descent to 1550 feet.

Airport Pattern Entry

This manual does not teach landing procedures. Please refer to the **Landing** section of the POH, and practice making good simulated landings in your spare time.

Landing the FS2 lacks in transfer to a real aircraft since depth cues are misleading. In these flight lesson modes, extra cues are provided with the outside view in order to discourage you from developing the bad habit of looking at the altimeter during landing flair. A thin black vertical bar appears slightly to the left of center on your windshield when you come within 100 feet of the ground, and second and third bars appear when within 50 feet and 25 feet respectively.

This manual will attempt to define good judgement goals when setting up for a landing. In a real aircraft (and with FS2), a good setup is 90% of a good landing.

In a real-flight training course your instructor (and texts) would cover the "legs" of a traffic pattern, "left traffic", "right traffic", and "pattern altitude". For the purposes of this text we will just point out that you should be at pattern airspeed and configuration, 800 to 1000 feet AGL, by the time you are two miles from the airport. Once in the airport pattern you'll have to use a lot of viewing angles to orient yourself with the runway. You should be in landing configuration (full flaps) at 66 to 70 kts on a half-mile final approach, at an altitude of 400 feet AGL, well-aligned with the runway.

Flight Lesson 5

VOR departure (instrument)
steep turns
accelerated maneuver stalls
VOR arrival (instrument)

limits:

altitude: +/- 150 feet (-0 feet on MDA)

airspeed: +/- 10 kts

rollout heading: +/- 15 degrees

course: +/- 2 miles

Select flight mode 9, taxi to runway 31, and perform preparatory steps 1, 2, 3, and 4. You'll make the same VOR departure as in Lesson 4. If you have a 64K system, press Q and select option A to begin course recording.

VOR Departure (instrument)

Remember the mistakes you made during VOR departure in the previous lesson. Make your takeoff and departure and climb to 4500 feet.

Review your course plot if desired. ESC into edit mode and set Cloud Layer 1 tops and bottoms to 0. ESC back to flight mode; you should be visual again.

Steep Turns

Steep turns are quite challenging. Your task will be to enter a steep bank of 45 to 55 degrees while maintaining altitude.

Apply full power. Make a 720-degree turn (two complete turns) to the right using a steep bank. As you roll into the turn you'll have to increase pitch at a faster rate than you're used to for 30-degree banks. You really have to anticipate the aircraft where pitch application is concerned. Also, don't forget to lower your pitch attitude when rolling out of the bank. Altitude gain is a common mistake during rollout. After rollout, reduce throttle to cruise RPM.

Repeat the maneuver, turning both left and right, until you're within the limits or at least until you get tired. You may want to review steep turns periodically during flight training. This maneuver should challenge your aircraft control for a long time. \$GHI

Accelerated Maneuver Stalls

An aircraft can stall at any airspeed if the stall angle of attack is exceeded. In a 60-degree bank you pull two Gs of acceleration (toward the center of the

circle), effectively doubling your weight relative to aircraft weight in level flight. More weight requires more angle of attack to support it. Stall angle of attack is reached at a higher airspeed than in normal flight.

Throttle back to 2000 (1700) RPM. Enter a steep bank and try to hold altitude using whatever pitch is necessary. Notice your high stall speed. Reduce bank angle and pitch to recover from the stall.

Accelerated maneuver stalls account for many “buzz job” accidents. If excessively steep turns don’t spoil your day, the quick pullup surely will.

Establish level cruise flight. Abruptly apply full up elevator. Lower your pitch to effect stall recovery. \$GHI

VOR Arrival (instrument)

\$fuel tank-mixture-carb heat-altimeter

You’re about to experience one of the true wonders of instrument flight, an ad hoc instrument approach to Willard Airport in bad weather. Be very careful not to descend below the recommended altitudes. In a real instrument approach, minimum altitudes are calculated to keep you at a safe height above any obstructions, given average radio navigation ability. You should hold these minimum altitudes sacred.

ESC into the editor and select mode 9. Enter a North coordinate of 16400, an East coordinate of 16340, and an altitude of 3500 feet.

Center the VOR CDI on the TO indication, then take up the heading given on the OBS. Descend to 2000 feet. When within six DME of Champaign, descend to 1500 feet. When within three DME of the airport, descend to 1200 feet. Carefully descend to an 1100-foot MDA using pitch control only. The airport should appear in front of you.

Flight Lesson 6

VOR tracking with wind

VOR practice

VOR approach

limits:

altitude: +/- 100 feet (-0 feet on MDA)

airspeed: +/- 10 kts

rollout heading: +/- 10 degrees

course: +/- 1 mile

Today's departure will be from runway 22. After you've gained 1000 feet of altitude (1750 MSL), turn right to intercept the 0-degree radial from Champaign VOR. Level off at 3500 feet (see Figure 23).

VOR Tracking with Wind

ESC to the editor, select User Mode 8, then set Shear Zone Altitude 1 to 6000 feet. Set surface wind at 20 kts, and set to 270 degrees. ESC back to flight mode.

The concept of "crab angle" could more appropriately be termed "drift angle". Your aircraft is not flying sideways, but rather straight ahead in a wind mass. The entire wind mass moves across the earth, and your resulting ground path is a vector sum of aircraft and wind movement. An excellent visual example would be a moveable piece of plexiglass placed over a stationary sheet of paper (see Figure 24). The plexiglass represents a moveable wind mass. The paper represents the ground. As you maneuver the aircraft straight across the plexiglass surface, have someone move the plexiglass straight across the paper's surface. Note your resulting groundpath on the paper.

This angle between heading and actual ground path is termed the *wind correction angle* (WCA). Finding the proper heading to track your selected VOR radial requires an application of common sense along with some well-managed trial and error responses.

Common sense indicates that with today's wind you will need a heading to the left of 360 degrees in order to hold course; say, 350 degrees. Well-managed trial and error is termed *bracketing*. Bracketing a VOR course is similar to good pitch control. If 350 degrees takes you left of course and 360 degrees takes you to the right of your desired course, then re-intercept your course and try a heading of 355 degrees. Continue to re-intercept course, then split the difference until you find the heading that holds your course.

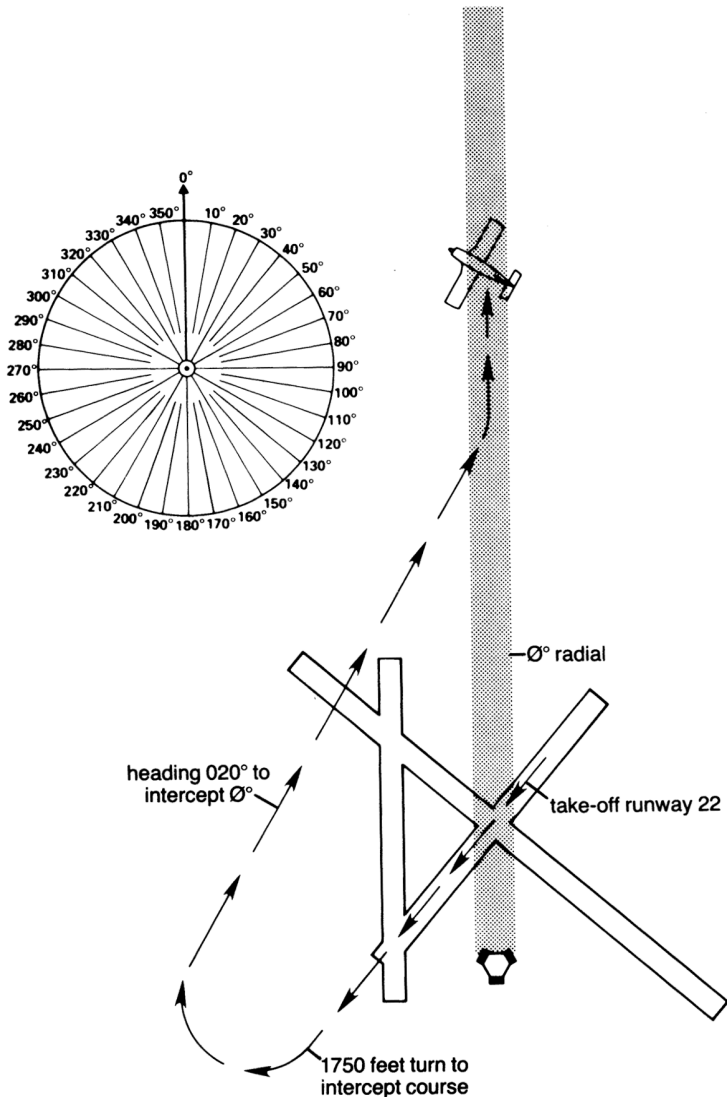
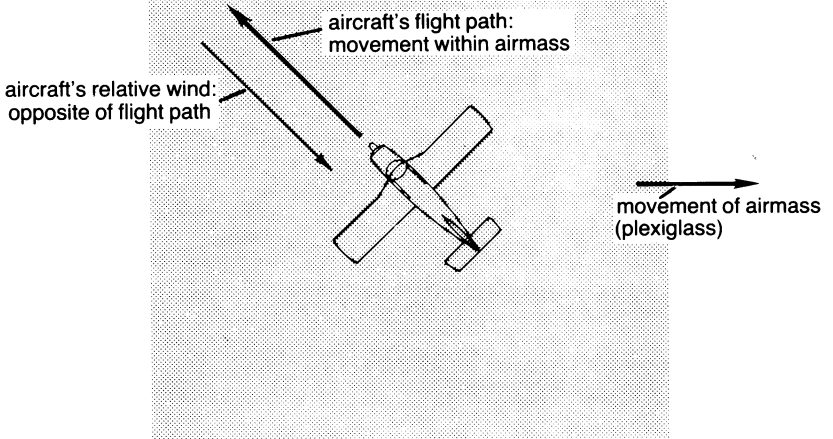

Figure 23. Flight Lesson 6 Departure

movable plexiglass



stationary paper (ground)

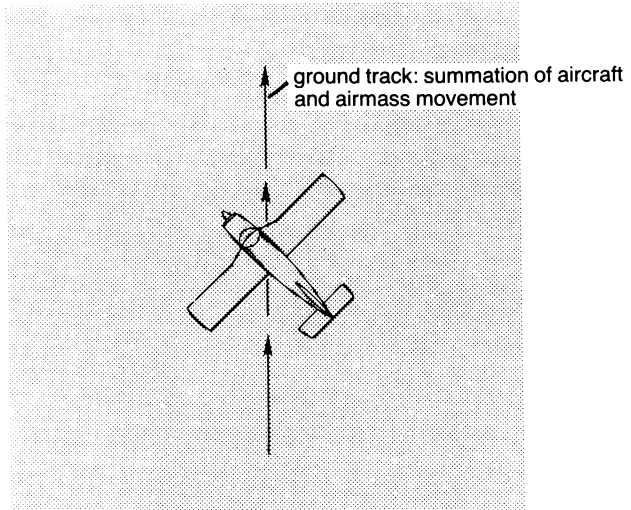

Figure 24. Visualization of Drift Angle

Another important concept related to VOR tracking involves changes in airspeed as, for example, when slowing for an approach. More wind correction angle will be required at slower speeds.

Note that your initial intercept angle is 20 degrees rather than 30 degrees. Since the wind is blowing you on course, 30 degrees may be too large an intercept angle. The 30-degree standard intercept is given as a general rule, but over time you will become more proficient at navigation. As your navigation skills improve you will learn to make intelligent decisions based on the factors involved; for example, if the wind is from 90 degrees rather than 270 degrees, you may wish to apply a 40-degree intercept angle rather than the 30-degree standard.

Don't let pride interfere with your performance. Even after many years as a flight instructor, I constantly consult a compass rose to aid in my navigation decisions. It may take you fifty hours of VOR navigation practice before you can easily visualize any navigation situation. Take it easy, apply good basics, and you will eventually acquire the necessary skills.

With winds from 270 degrees at 20 kts, it will require a 10-degree left WCA (350-degree heading) to hold the 0-degree radial. We're telling you this ahead of time because there is one additional factor that will complicate your departure.

As you takeoff from runway 22, you are south of the airport. You will get a TO indication on the TO-FROM-OFF flag. The flag is automatic, given the course you've selected. Since you are south of the VOR station, your position will be 0 degrees TO. You'll experience station passage abeam of the the VOR after you turn to the intercept heading of 20 degrees. Should you intercept course before station passage, navigate the 0-degree TO course. The flag will automatically switch to FROM upon station passage.

You're likely to overshoot the 0-degree course in any case, since your intercept will occur in close proximity to the VOR, an area where one degree may encompass only fifty feet of ground. Don't overbank in an attempt to intercept. In such a case overshooting is perfectly normal. Instead of overbanking, just head to about 335 degrees and re-intercept.

As you can see, this departure is more difficult than previous ones. Keep practicing until you get it right, and then take pride in your accomplishment.

Perform preparatory steps 1, 2, 3, and 4. Takeoff (a heading of 222 degrees will keep you on runway 22), climb to 1750 feet, turn to intercept course, and level off at 3500 feet. Stay on course (350-degree heading at cruise speed). Slow to pattern airspeed and configuration. Find the new heading that tracks the 0-degree radial.

VOR Practice

Throughout the following maneuvers, remember that aircraft control has priority over navigation and NAV radio setting:

Track 180 degrees to Champaign VOR (switch the OBS to 180 degrees and head toward the station).

After station passage, reset the OBS and track 270 degrees from the station until 10 DME west of Champaign VOR.

Once 10 DME west, turn left to a heading of 225 degrees for one and a half minutes. Change the OBS to 090 degrees. Turn right to a heading of 45 degrees and intercept the 90-degree course to Champaign VOR. \$GHI

After station passage, reset the OBS and track outbound on the 180-degree radial from the VOR until you're 10 DME south. As soon as you are 10 DME south, turn left to 135 degrees for one minute. Set the OBS to track inbound 0 degrees to the VOR. Turn right to 315 degrees and intercept the 0-degree course inbound. Once inbound, press the P key and read the following section.

VOR/DME RWY 22 Approach to Willard

Note that only 2-degree increments are available on your OBS selection. Some published radials must be modified by adding one degree. Consult the approach chart (Fig. 25) and Figure 26.

\$fuel tank-mixture-carb heat-altimeter

The following explanation will be brief. You may not find all points covered on the approach chart. Refer to the *Instrument Flying Handbook* (see **Flight Training Aids** section of the POH) for complete descriptions.

VOR/DME RWY 22

UNIVERSITY OF ILLINOIS-WILLARD (CMI)
CHAMPAIGN-URBANA, ILLINOIS

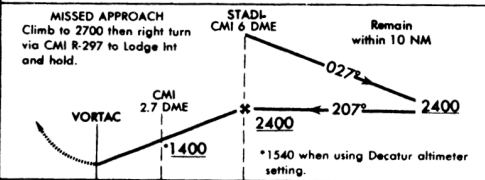
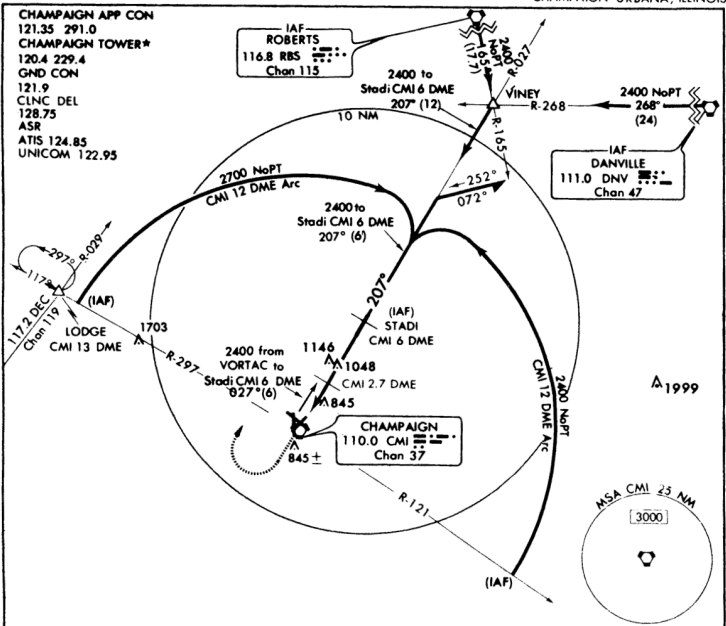

CATEGORY	A	B	C	D
S-22		1100-1 351 (400-1)		1100-1 1/4 351 (400-1 1/4)
CIRCLING	1160-1 406 (500-1)	1220-1 466 (500-1)	1220-1 1/2 466 (500-1 1/2)	1320-2 566 (600-2)

When control tower closed, activate MALS Rwy 31-120.4, except for operators approved weather reporting services: 1. Use Decatur altimeter setting. 2. Increase all MDAs 140 feet. 3. Alternate minimums NA.

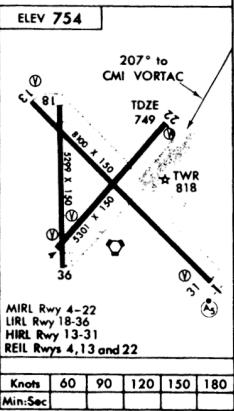

VOR/DME RWY 22

40°02'N-88°17'W

CHAMPAIGN-URBANA, ILLINOIS
UNIVERSITY OF ILLINOIS-WILLARD (CMI)

Figure 25. Dated Material – Not for use in real navigation

Descend to the minimum safe altitude of 3000 feet (MSA CMI 25 NM 3000: lower right corner of plan view).

After station passage, depart the VOR at 028 degrees (follow the 207-degree line all the way up on the plan view and note the "R-027" pointing outbound). Descend to 2400 feet. Slow to pattern airspeed and configuration.

Wait three minutes after passing STADI intersection, 6 DME fix (remain within 10 NM of the "X" final approach fix: profile view).

Make the procedure turn to 072 degrees for one minute, set the OBS to 208 degrees, turn left (away from the airport) to 252 degrees, and intercept the 208-degree course inbound (plan view).

Passing STADI intersection inbound (6 DME), descend to 1400 feet minimum (profile view: 1400, with underline meaning minimum).

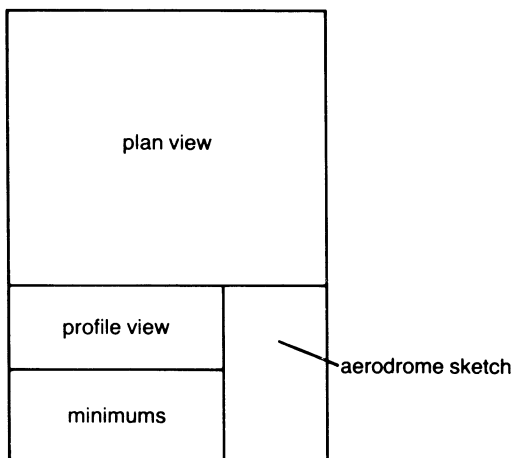

Figure 26. Approach Chart Terminology

After 2.7 DME inbound, descend to 1100-foot MDA if landing at runway 22 or to a 1160-foot MDA if circling to another runway (minimums section). On a critical minimum descent altitude, remember to level off 100 feet above the desired altitude and then pitch down to minimum altitude.

Once you see the runway and are aligned in a position to make a normal landing approach, you may let down for landing. If you do not see the airport and pass the VOR, then execute the missed approach procedure (profile view). If you become disoriented at any time during your approach, climb for safety, track to the VOR, and then execute the missed approach procedure or re-attempt the approach.

Repeat this flight using Mode 9 (instrument flight mode).

Flight Lesson 7

cross-country flight

limits:

altitude: +/- 100 feet

airspeed: +/- 10 kts

rollout headings: +/- 10 degrees

course: +/- 1 mile

Cross-Country Flight

Paxton Airport is a small airport with a north-south strip, 25 NM from Champaign on an approximate 016-degree heading from Willard Airport.

Pilots primarily use three methods for navigation:

1. Pilotage – locating landmarks such as cities, roads, airports, and other prominent visual features. FS2 landmarks are well-defined along the route to Paxton. Other areas may not have as much scenery since the FS2 disk is completely full. Extra scenery disks available for different areas are dedicated to scenery, and include more prominent landmarks.

2. Radio Navigation – VOR and NDB navigation are used in both visual and instrument conditions. Where airways are not marked, you may check an airport/facility directory for possible VOR problems and, when applicable,

draw a line between two VORs or a VOR and an airport, estimating the radial on the compass rose.

3. Dead Reckoning – calculating headings and time to fixes or airports based on predicted or observed winds aloft.

Good pilots use all three methods when possible. For today's flight to Paxton, apply the three primary methods as follows:

Pilotage – Note the towns and roads shown in Figure 27. These will be visible on your flight. (A Chicago Sectional chart may be used instead of Fig. 27).

Radio Navigation – Draw a line (on your area chart) from Willard Airport (VOR on field) to Paxton Airport. A good radial estimate would be the 016-degree radial from Champaign VOR.

Dead Reckoning – Measure the distance to Paxton. 25 NM / 130 NM per hour yields .19 hours to Paxton Airport. .19 hours x 60 minutes/hour 11.5 minutes to Paxton. As a general rule you should add one minute per 1000 feet of climb to your enroute time estimate. Today's flight will be at 3500 feet (almost 3000 feet AGL), so assume 14.5 minutes at a heading of 016 degrees to Paxton.

For purposes of visual traffic separation, plan your cross-country cruising altitudes as follows:

Direction (ground tack)	Altitude
0 - 179 degrees	odd thousands + 500 feet
180 - 359 degrees	even thousands + 500 feet

These cruising altitudes begin at 3000 feet AGL and are regulatory.

Perform preparatory steps 1, 2, 3, and 4. In flight, \$GHI. Before landing, \$fuel tank-mixture-carb heat-altimeter. See you when you get back!

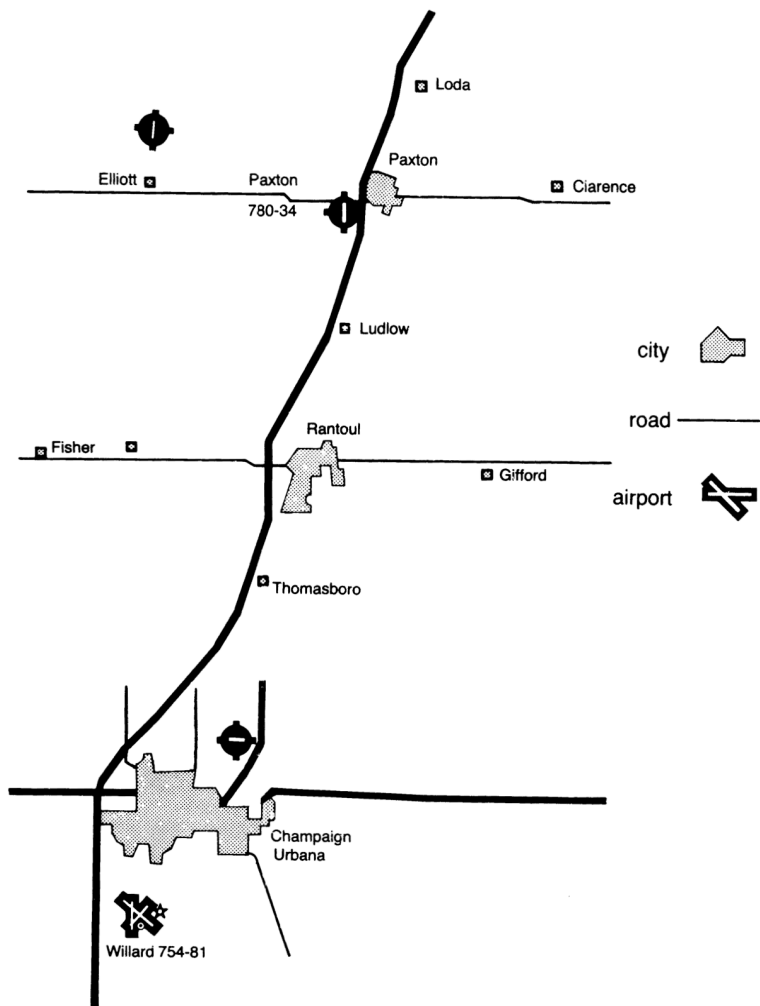

Figure 27. Landmarks – Champaign to Paxton

Flight Lesson 8

ILS approach

limits:

altitude: +/- 100 feet

airspeed: +/- 10 kts

rollout headings: +/- 10 degrees

course: localizer = within CDI readings.

glideslope (outer marker inbound) = $\frac{2}{3}$ down indication
0 up indication

ILS Approach

ILS stands for instrument landing systems, a set of navigation facilities including localizer (horizontal guidance), glideslope (vertical guidance), and distance information.

Localizer – Imagine a VOR that can be used on only one radial, lined up with the runway. Imagine that your VOR's CDI reads just five degrees (instead of 20) from CDI pinned right to CDI pinned left. The localizer works irrespective of your OBS setting, but many pilots prefer to set the final approach course, on the OBS, as a course reminder.

Glideslope – Imagine a localizer turned sideways and aimed upward 3 degrees from ground level, with a full-scale (up/down) needle deflection of only 1.4 degrees.

Distance Information (marker beacons) – Upward-transmitting marker beacons (received when you're directly above the beacon) are placed along the localizer course several miles from the runway and about a half mile short of the runway.

These instrument landing systems allow you to make a precision approach, precise enough in most cases (given a lack of obstacles and good approach lighting) to guide you down to a decision height of 200 feet AGL, one-half mile short of the runway.

ILS RWY 31

UNIVERSITY OF ILLINOIS-WILLARD (CMI)
CHAMPAIGN - URBANA, ILLINOIS

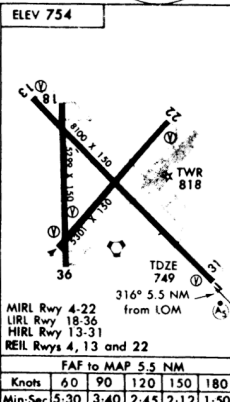
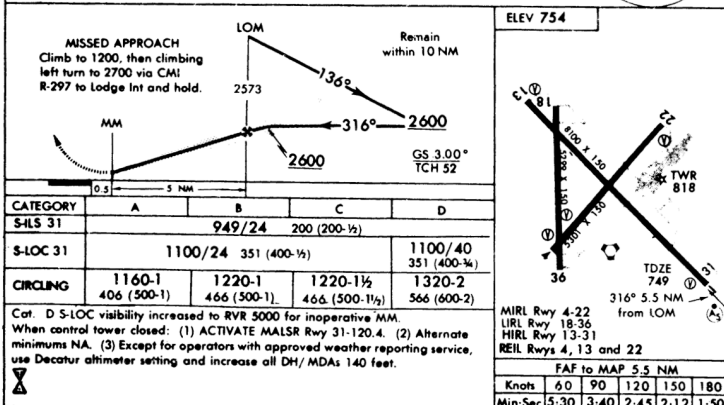
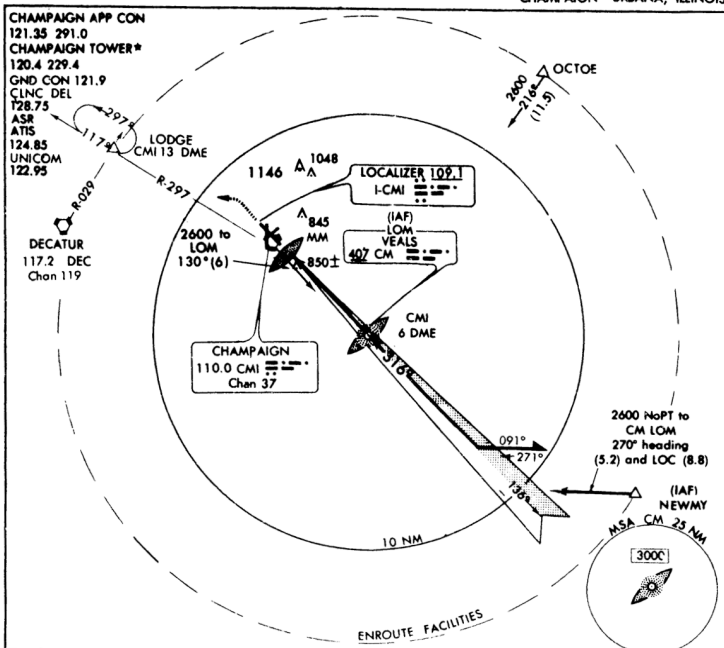

ILS RWY 31

40°02'N - 88°17'W

CHAMPAIGN - URBANA, ILLINOIS
UNIVERSITY OF ILLINOIS-WILLARD (CMI)

Figure 28. Dated Material – Not for use in real navigation

Tracking the localizer requires very small corrections compared to VOR radial tracking. Tracking a localizer outbound from an airport also requires that you use reverse logic; remember, the OBS is non-functioning so you can't set the reciprocal course. When tracking a localizer outbound you have to take corrective headings opposite to the CDI indication. (On your first ILS approach you won't have worry about tracking outbound.)

Tracking a glideslope takes good basic pitch control. Always use pitch to track the glideslope, and adjust power to control airspeed.

Set mode to 9, then adjust Cloud Layer 1 tops and bottoms to 3000 and 1000 feet respectively if you'd like to do the approach under instrument conditions. Set winds as desired.

Tune NAV 1 to frequency 109.1. Set the OBS to 314 degrees* just as a final course reminder. CTRL N, 2 and set NAV 2 frequency to 110. CTRL N, CTRL N and set the fractional frequency to .00. CTRL V and set the NAV 2 OBS to 160 degrees.

You will track outbound on the 160-degree radial on NAV 2 for 20 DME. Level off at 3000 feet. \$fuel tank-mixture-carb heat-altimeter. \$GHI. Turn left to a heading of 360 degrees (dead reckoning to the localizer). Slow to pattern airspeed and configuration. As the localizer needle comes in, turn to 315 degrees +/- WCA. Descend to 2600 feet. The up/down glideslope needle should be pinned up, indicating that the glideslope is above you. Most localizers don't have DME associated with them, but all FS2 localizers include DME.

The glideslope needle should center about 6.5 NM from the airport. Reduce power to maintain 90 kts and use pitch to keep the needle centered. When you're approximately six miles from the airport, the outer marker light should start blinking. One-half mile out or so you should break out of the cloud cover (assuming you've set clouds) and the middle marker light will start blinking. If you can successfully fly the ILS 31 approach to the 949-foot decision height, congratulations!

* The approach chart references 316 degrees for the final approach course, but when the localizer data was installed in your FS2 the course was 313 degrees. Changes in magnetic variation can cause listed magnetic courses to change over time.

NOTE: Acquiring Approach Charts

Unlike FAA books and Sectional Navigation charts, Instrument Approach Procedure charts are available by subscription only. Should you wish to practice other approaches, call SubLOGIC and inquire as to the availability and price of a set for the FS2.

Recommended Alterations to Flight Lessons

Once you've become confident in your aircraft control, we recommend practicing maneuvers in reality mode where you will have to set the altimeter and heading indicators. We also strongly urge you to practice instrument flight with light turbulence. Practicing maneuvers with turbulence will greatly improve your instrument scan. Consult the **Environmental Factors** section of the POH to learn how to set turbulence.

Section Three – Introduction to Aerobatics

The Spin

The spin is the simplest truly aerobatic (or acrobatic, if you prefer) flight maneuver. Virtually any flying airplane is capable of spinning, although it is not a recommended maneuver for most larger aircraft. Accidental spins account for five to ten percent of all small airplane accidents in any given year, so it is important to become familiar with the maneuver. Current U.S. pilot certification standards stress spin (and accidental stall) prevention rather than recovery, but many flight instructors choose to teach the complete maneuver.

Axiom #1 – No airplane can ever spin unless it is stalled. A spin is simply a stall where one wing stalls before the other. This causes one wing to drop before the other, and the airplane begins a corkscrewing nose-down descent. Once the spin is fully developed the aircraft will tend to remain in the spin – *autorotating*, as it is called – until the pilot moves the controls to stop the stall and to stop the rotation. Are you ready to try one?

First put your simulator in the uncoordinated flight mode (auto-coordination = 0) and climb to a safe altitude of at least 6,000 feet above the ground. Then, with the aircraft in cruising flight condition (flaps retracted), bring your throttle back to idle power. Use the elevator to slowly raise the nose to a point slightly above the horizon. Hold this flight attitude until a stall warning is indicated. Then apply additional up elevator and add full rudder – left or right (your choice), depending on whether you wish to spin to the left or to the right. You will see that the airplane rolls (and yaws), as a result of the rudder application, to a 90-degree bank position and beyond as the spin develops. (See Fig. 29.)

To recover from the spin you must recover from the stall (since the stall is the precursor to and real reason for the spin), but the most efficient recovery will start with full rudder opposite to that used to start the spin. This will stop the rotation. Then apply down elevator to reduce your angle of attack. Remember, if you're not certain which rudder to apply, look at the model of

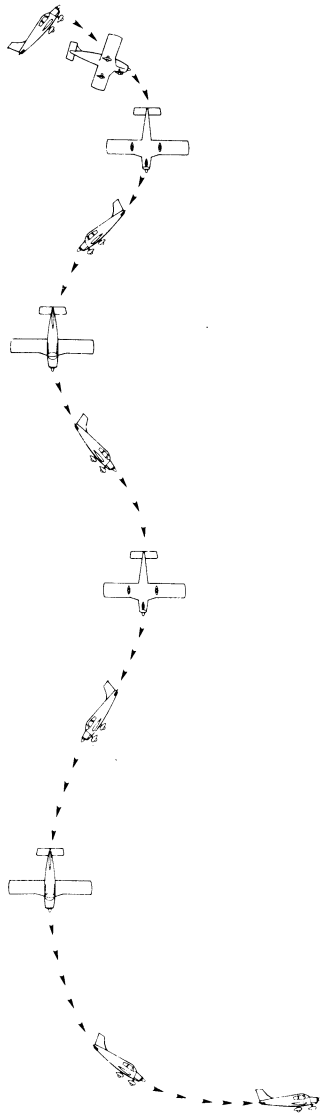

Figure 29. The Spin

the airplane on the turn coordinator. If it says LEFT, apply right rudder, and vice versa. To complete recovery, apply up elevator to raise the nose to the horizon. Do this rather quickly after stopping your rotation, to avoid diving to too fast an airspeed and to avoid running out of altitude! Be careful, however, not to apply too much up elevator too quickly or you risk yet another stall.

The Loop

The loop is the second simplest aerobatic maneuver. The object is to use the elevator (and throttle) to pitch the airplane through 360 degrees of pitch, thereby flying a vertical circle in the sky. One difficulty is that whenever the nose is pitched (raised) well above the horizon, there is obviously a danger of stalling. The key to a successful loop is to obtain enough airspeed (energy) so as to allow the airplane to fly through this vertical circle without exceeding its maximum angle of attack and therefore stalling.

Remember, angle of attack is not directly related to the horizon. It is related to how the oncoming wind produced by the airplane's flight path (the relative wind) strikes the airplane, particularly the airplane's wings. If the pilot tries to fly too small a loop by pulling too much up elevator, he or she will force the angle of attack to too great an angle and cause a stall. On the other hand, if the size of the loop is too great, too much speed will be lost (especially during the first uphill half of the loop) and the angle of attack will increase as the speed diminishes. Again, the airplane will stall. Obviously, the faster and more powerful an airplane is, the more easily it can be looped.

Are you ready? This time you can leave the simulator in the auto-coordinated flight mode (auto-coordination = 1) since no significant separate use of rudder and ailerons will be required. Again, climb to a good safe high altitude at least 6,000 feet above the ground. Configure your airplane in normal cruising flight condition (flaps retracted) at normal cruising throttle.

Using your elevator, dive the airplane rapidly until your airspeed nears 200 kts. Now apply up elevator smoothly but not too rapidly, until your elevator position indicator (POH Figure 1, item 24) shows about three-quarters up

elevator. Then look straight ahead. You will see the nose of the airplane rise until nothing but blue sky is visible.

Now apply full throttle. At this point most experienced aerobatic pilots recommend looking directly off one wingtip or the other. This allows you to keep your orientation by watching the wing move (pitch) against the horizon off to the side of the airplane.

When the loop is nearly halfway complete (see Fig. 30), switch back to forward view and watch the earth re-appear upside down through your window. Your airplane's orientation can also be seen on the attitude indicator.

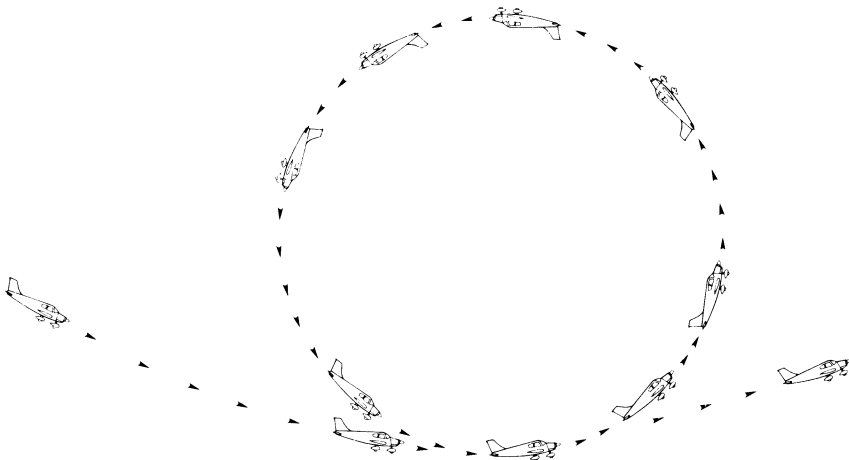

Figure 30. The Loop

Once the loop is about three-quarters complete, bring the throttle back to near idle to avoid over-revving your engine as you dive rapidly. During this vertical dive you will see only the ground through the front window. When the horizon reappears, apply throttle as desired and resume cruising flight.

Aileron Rolls

Another basic aerobatic maneuver is the aileron roll (or barrel roll). In this maneuver the ailerons are used to roll the airplane through 360 degrees of bank. It will be helpful if you again select the auto-coordinated flight mode, since in this airplane no rudder use is required. This maneuver is fairly simple to accomplish, as your airplane has the capability for a very rapid rate of roll (much like jet fighter aircraft currently flown by the military). As a matter of fact, one of the most difficult elements of the aileron roll in this aircraft will be getting your airplane to stop rolling at the proper time. Ready? Here we go.

In the uncoordinated flight mode, in cruise configuration with cruise speed and power, begin a shallow dive to pick up some extra airspeed. When you have accelerated to 30 kts above normal cruise speed, use the elevator to raise the nose to a point only slightly above the horizon. The airplane is now climbing slightly due to its excess speed and pitch attitude.

Now neutralize your elevator. Apply aileron in the direction you wish to roll. Watch the earth's horizon carefully through the forward window. You will see the airplane roll past a vertical bank, through an inverted bank, and into an opposite vertical bank (i.e., with the other wingtip sticking straight up). Begin to neutralize your ailerons shortly before you are level again. If properly timed, you will find yourself once again in a near level flight attitude. (See Fig. 31.)

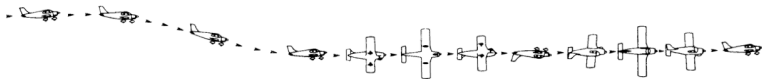

Figure 31. Aileron Roll

Inverted Flight and the Split-S

Inverted, or upside down, flight is a disorienting experience even when not accompanied by the physiological sensation of hanging by your heels! You went through this flight maneuver momentarily while accomplishing the aileron roll. This time, however, begin neutralizing your ailerons shortly after rolling past vertical so that you stop rolling as the airplane comes upside down.

At this point both the earth's horizon and your attitude indicator will show an upside down world. To experiment further, push your elevator slightly down. Normally this would cause the nose to drop down and increase your airspeed, but look what happens now! Down elevator forces the nose to move away from the earth (or uphill, if you will). This inverted climb causes your airspeed to decrease and the altimeter reading to increase. Now apply a little up elevator to bring the nose back toward the earth's horizon, or you will soon be in an inverted stall.

While it may seem that the airplane's elevator has reversed functions (up for down and vice versa), this is only true in reference to the earth below (above?) you. Up elevator still moves the nose of the airplane toward the nose on your face as you sit in the cockpit; down elevator still moves the nose of the airplane away from your own nose. As you can see, notions of up and down are relative and dependent on your physical orientation. (See Fig. 32.)

To recover to level normal flight, simply complete the last half of your aileron roll in either direction. It is also possible to go from inverted flight to normal flight by simply applying up elevator, closing the throttle, and doing the last half of a loop. This maneuver is called a Split-S since the airplane flies the

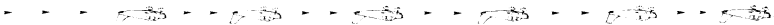

Figure 32. Inverted Flight

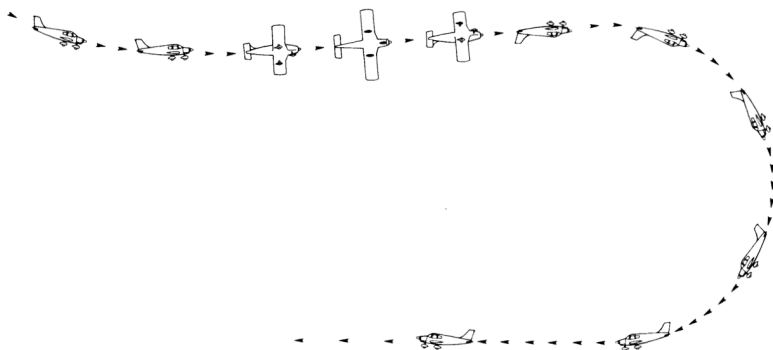

Figure 33. The Split – S

last half of a letter S drawn vertically in the sky (see Fig. 33). However, this Split-S should not be attempted in actual flight unless your airspeed is slow and your altitude quite high. Otherwise the radius of the half-loop will be so large that the airplane may be overspeeded and/or overstressed. Also, the Split-S maneuver does not develop in a pilot the proper safe habit pattern response that he/she should know in case of accidental inverted flight. The proper and safest habit pattern response is the last half of the aileron roll previously described.

The Immelman

The immelman turn was invented or discovered by a German Ace, Max Immelman, and was used as a tactical maneuver to evade other aircraft in a dogfight. Simply described, the immelman turn is a half loop followed by a half roll. (Note that the Split-S previously described is the reverse, a half roll followed by a half loop.)

To accomplish the immelman, configure the airplane exactly as described for the loop. Note your heading and begin a loop. Neutralize the elevator just

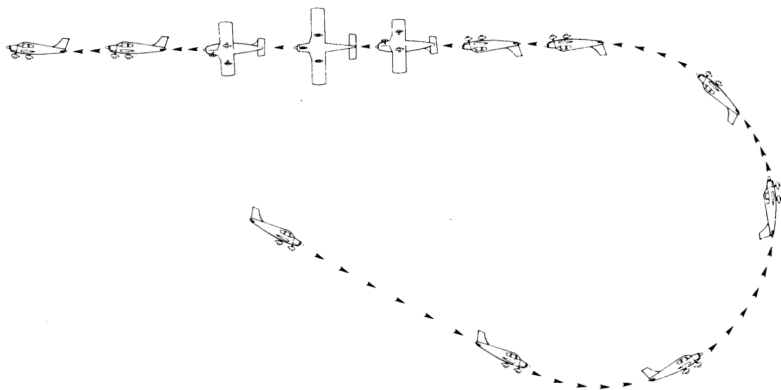

Figure 34. The Immelman

at the moment the airplane becomes exactly inverted at the top of the loop (or a moment or two later). This will stop the airplane in inverted flight at a relatively slow airspeed, and you can then follow through with the half roll portion of the maneuver.

Note that the airplane must be held in the loop until it is completely inverted or even pitched slightly nose below the horizon. If you stop the loop too soon, with the airplane inverted but the nose pointing above the horizon (uphill), you will start an inverted climb which could easily lead to a stall while you're attempting the half roll portion of the maneuver. If you continue the loop to a fully inverted position or even a bit beyond, gravity will help you (or at least not hinder you). (See Fig. 34.)

The Hammerhead Turn

The hammerhead turn, also called the hammerhead stall, is a simple-looking maneuver that is actually fairly difficult to perform well. It is sometimes loosely referred to as a wingover since that describes what the airplane does, but other less-difficult flight maneuvers can also be called wingovers.

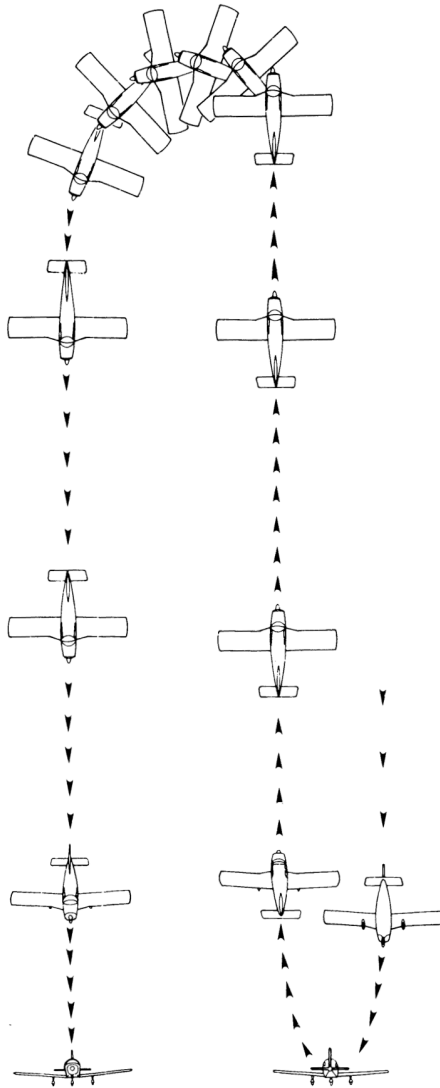

Figure 35. The Hammerhead

Begin in the uncoordinated flight mode and dive for airspeed exactly as though you were going to start a loop or an immelman. Look out the side window, however (just as in a loop), and stop the airplane's loop just as the bottom of the wing comes up perpendicular to the horizon. Do this by neutralizing the elevator or perhaps even applying slight down elevator if the loop tends to continue by itself due to the high speed of the airplane.

You are now in a (momentary) vertical climb, but even with full power the airplane will slow down rapidly. When the airspeed has dropped to about 80 kts, leave the elevator where it is and smoothly apply full left (or right) rudder. Look out the left window if you are using left rudder, and vice versa.

The airplane will now yaw around its center of gravity until the nose is pointing straight down toward the earth. However, as rudder is applied during the actual hammerhead part of the maneuver, the yawing of the airplane will be because the top wing (the right wing if yawing with left rudder) to have a faster speed than the bottom wing (the left wing in this case). Try this maneuver with a model airplane or even with your hand and you will see that this is so. This differential airspeed over the two wingtips creates more lift on the faster top (right) wing and less lift on the slower bottom (left) wing. If uncorrected, this will cause the airplane to roll slightly over onto its back and destroy the symmetry of the maneuver.

How can you prevent this? The use of opposite aileron (right aileron in this example) will counteract the differential wingtip speeds and keep the plane from rolling onto its back. If this sounds a bit tricky, it is! As mentioned, this is a fairly complex maneuver that appears simple when performed correctly.

Once the nose has yawed through 180 degrees from straight up to straight down, you should quickly close the throttle, neutralize all flight controls momentarily, and then rapidly but smoothly apply up elevator to recover from the vertical dive back to level flight. You should now be heading in the opposite direction from the heading on which you started. (See Fig. 35.)

The English Bunt

The English bunt is half of a loop, but unlike the loops previously attempted it is half of a loop executed with down elevator – an inverted or outside loop.

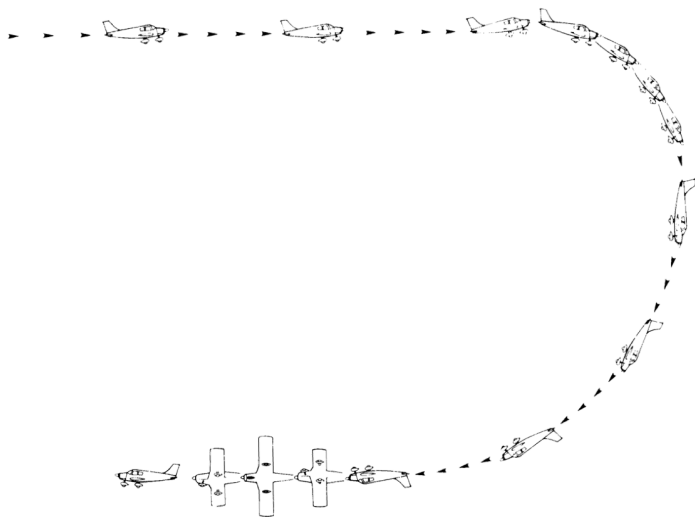

Figure 36. The English Bunt

The normal loop described previously is more formally known as an inside loop – a loop performed with up elevator. The English bunt or half outside loop subjects the pilot in flight to a definite and quite noticeable negative “G” load. Centrifugal force and gravity combine to force the pilot out of his seat; if the seat belt is not secured he will be forced into the ceiling of the plane or, in the older open-cockpit airplanes, completely out of the plane. This has happened to pilots in open-cockpit airplanes on more than one occasion. In fact, this principal was used to efficiently eject from airplanes long before ejection seats were invented.

To perform the neck-stretching English bunt, configure your airplane in the uncoordinated flight mode in normal cruise flight. Make sure that you are at least 9,000 feet above the ground; you may need lots of room. Slow the airplane down to 60-65 kts and close the throttle. Smoothly apply down elevator (about one-half to three-quarters full down) and maintain it as airspeed increases and altitude begins to decrease rapidly. You will be going into a power-off (idle power) vertical dive and beyond! Once you see

nothing but ground through the front window, you may choose to look directly off a wingtip as you did in the normal (inside) loop, or you can continue to look forward.

When you first see the horizon appear upside down through the front window, reduce down elevator and allow the airplane to stop pitching in an inverted flight attitude. Now simply perform a half aileron roll back to level flight (see **Aileron Rolls** section). You should have plenty of airspeed at this point even with the throttle closed, courtesy of all the altitude that you dove off during your half outside loop. (See Fig. 36.)

Conclusion

You are now familiar with the basic aerobatic maneuvers. Virtually all advanced aerobatics are just combinations of the maneuvers described here. Feel free to experiment in your simulator; you can't hurt it or yourself. **BUT A WORD OF CAUTION:** Please do not attempt these maneuvers in actual flight with a real airplane of any type unless accompanied by a qualified flight instructor experienced in aerobatics. The reason for this admonition should be quite obvious, so please heed it. Furthermore, some simplifications have been made in adapting this curriculum to your flight simulator. A wise pilot would no more attempt to teach himself aerobatic flight without an instructor than he would try to learn how to fly solo without instruction. Happy landings!

Suggested Bibliography:

Roll Around a Point, by Duane Cole. Ken Cook Co., Milwaukee, WI

Primary Aerobatic Flight Training with Military Techniques, by Art Medore.

Both books available from: Aviation Book Company

1640 Victory Blvd.

Glendale, CA 91201

(213) 240-1771

Notes

Notes

Notes

Notes

